

INNOVATIONS IN POWER DISTRIBUTION

Safe. Reliable. Efficient.

POWER BUS WAY[®]

Power Bus Way cable bus is a smart alternative to bus duct, cable tray and duct bank distribution systems.

TABLE OF CONTENTS

Introduction	2
Cable Bus	3
Capabilities	5
Project Execution	7
Commercial/Institutional	9
Data centers	17
Oil and Gas	29
Power Generation	35
Industrial	41
Renewable Energies	49
Technical Specifications	54
Custom Electrical Enclosures	55
Accessories	57



INTRODUCTION

S Since 2006, Power Bus Way has provided hundreds of satisfied clients with fully customized, high quality, and cost effective power feeder systems. For us, no project is too big or too small. Whether indoors or outdoors, we will create a power feeder system that is both reliable and virtually maintenance free.

Our unique engineering process enables us to quickly and accurately create a product that is completely customized to suit your needs. We achieve this while staying on budget and on-time.

Headed by a unique team of engineers and designers, we have the latest technologies, equipment, and knowledge on hand, enabling us to provide the best solutions every time. From application engineering, to 3D site scanning, testing, and on-site support, we do it all!

Both standard and custom-designed power feeder systems are crafted in our 20,000 sq. ft. state of the art, ISO 9001:2015 certified manufacturing facility. Our specialized team will ensure that all systems and components are manufactured to the highest levels of performance and quality.

For cost effective solutions and straightforward installations with an unparalleled customer service experience, you can rely on Power Bus Way.

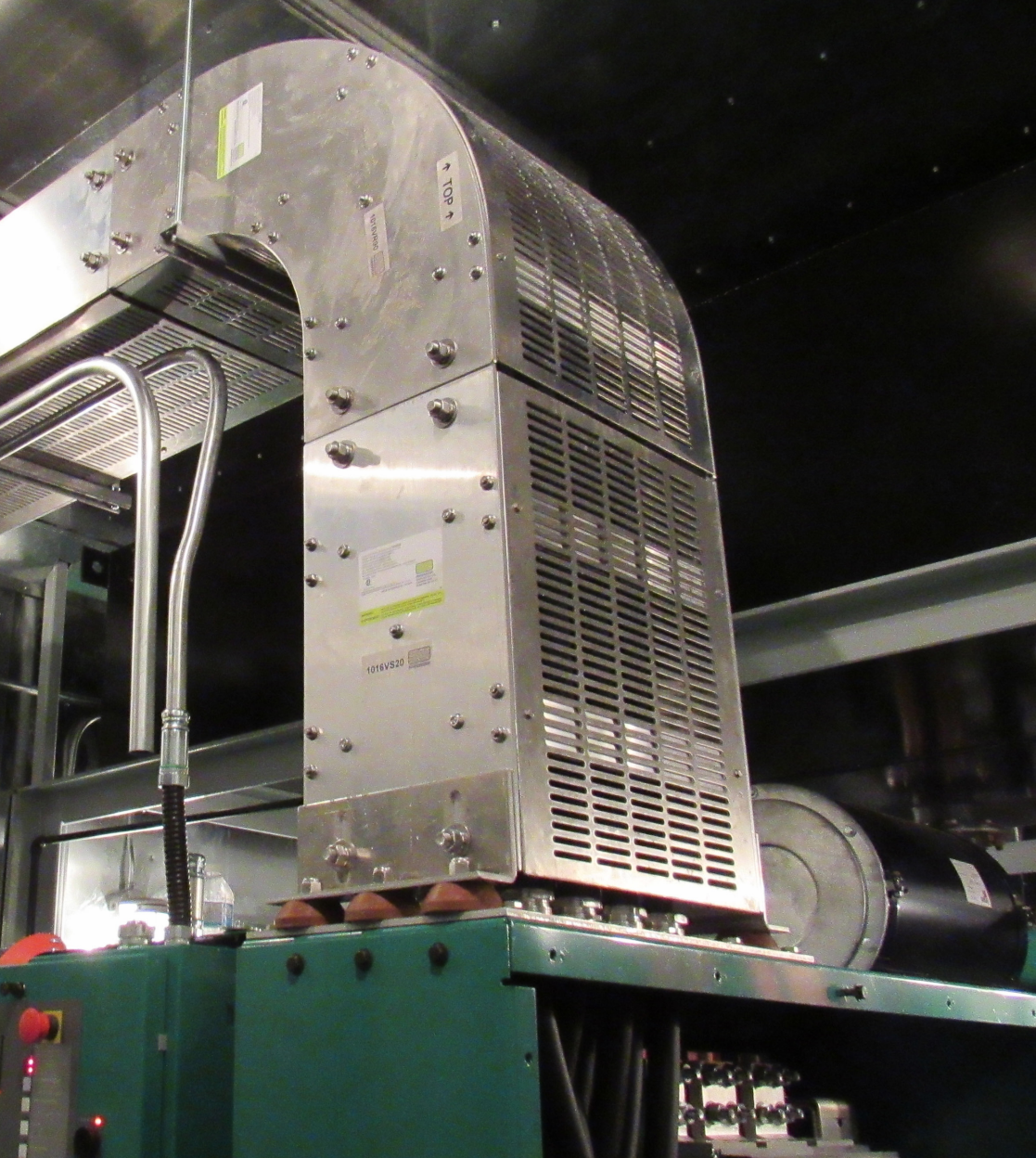

CABLE BUS

P

ower Bus Way cable bus is a perfect hybrid of cable raceway and bus duct. It is an ideal solution for a variety of projects.

Our cable bus combines the performance, flexibility, and all-weather reliability of insulated power cables with the engineered design and short circuit rating of a bus duct.

The Power Bus Way cable bus is the first to be certified to the CSA 22.2 No. 273-14 standard. This certification is the result of countless hours of research and development, creating a power distribution system that is the safest, most reliable, and the most efficient compared to any other system in the marketplace.

Our in-house team, with over 100 years of combined experience in electrical contracting, ensures that our Power Bus Way cable bus is also easy to install and maintain.

✓ Voltages up to 69kV

✓ Ampacities up to 8,000A

✓ Suitable for all environments

✓ Fully certified

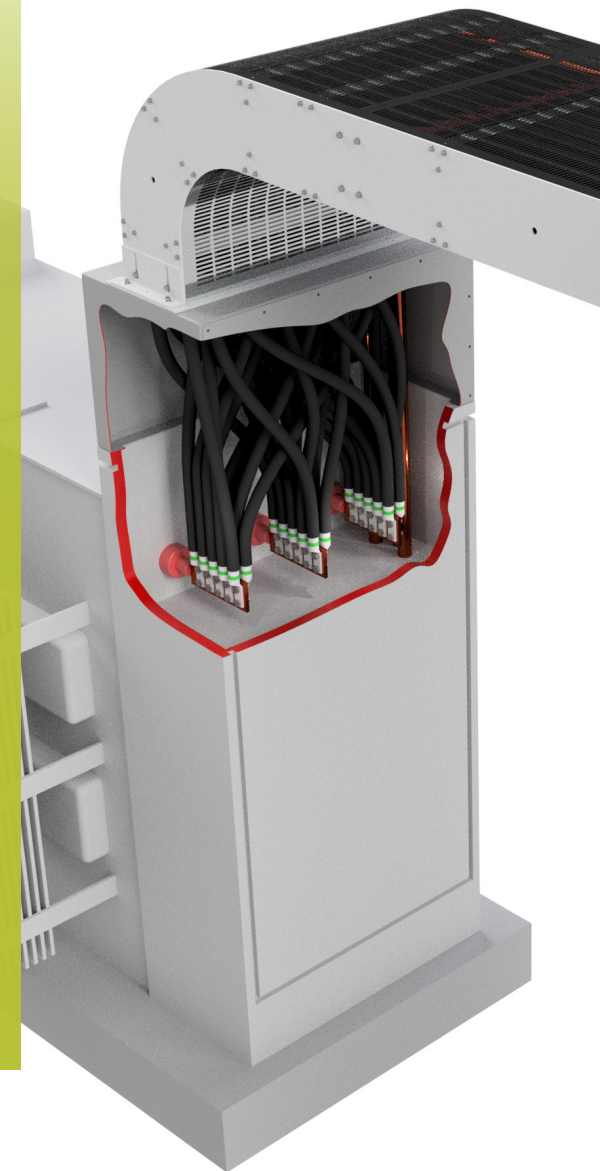

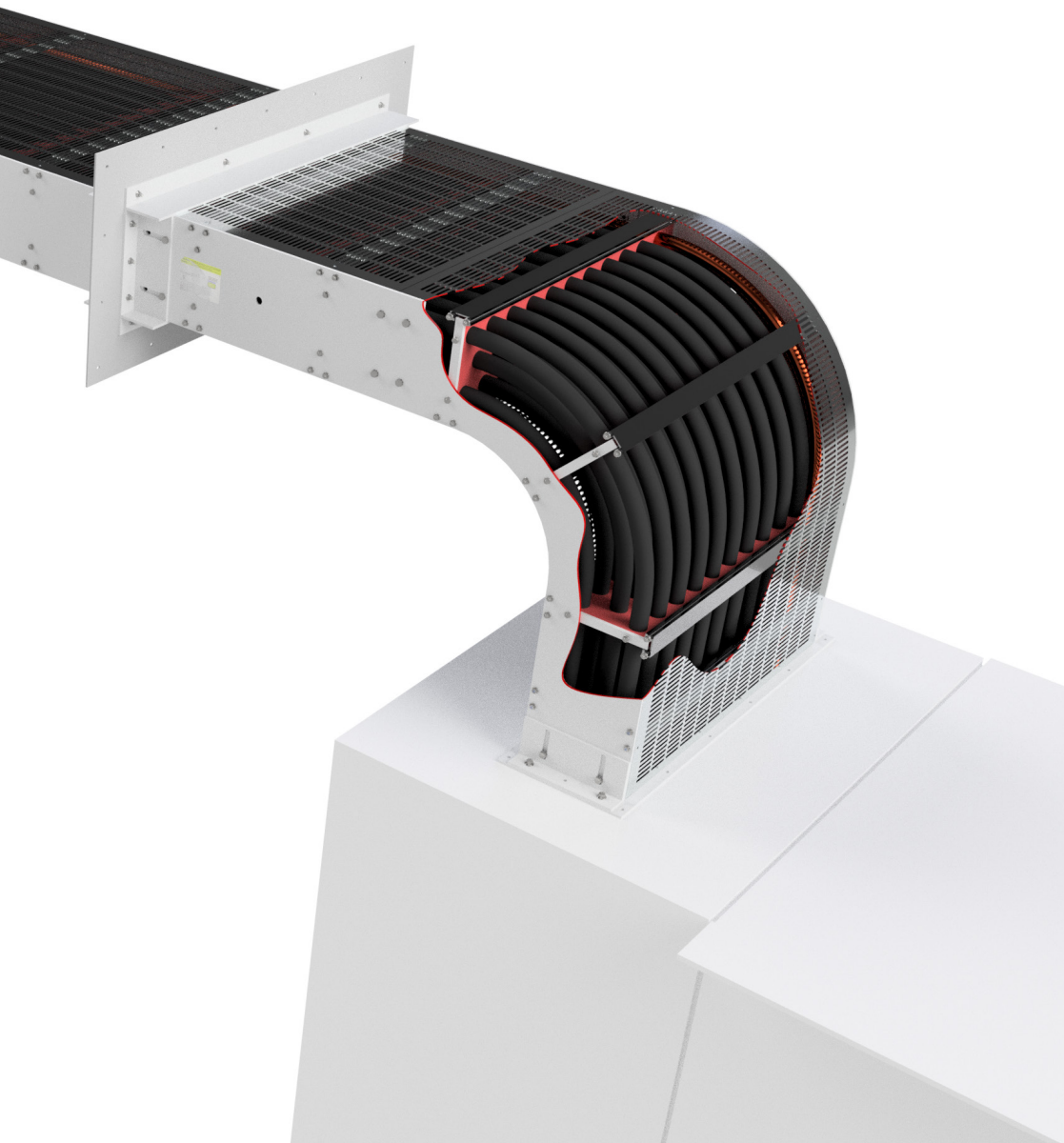

No two projects are the same. All Power Bus Way systems are fully engineered to fit the unique requirements and specifications of a project. It is manufactured using the highest quality components in the industry, including:

- End-to-end fully insulated and UL/CSA certified power cables
- Rugged, heavy duty NEMA/CSA certified enclosures for ultimate protection - with no field cutting required
- Sturdy and flame-resistant cable support blocks that maximize the efficiency of conductors by maintaining spacing between cables

We also supply all accessories needed for each cable bus system. From entrance plates, firestops, and termination lugs and/or kits, to external supports, transition boxes, and bus adaptors; we have it covered. We also provide a customized interface to ensure a seamless connection between existing and new equipment.

CAPABILITIES

As Power Bus Way designs and manufactures everything in-house, the possibilities are endless. Each system is customized to suit any project's requirements.

We are ISO 9001:2015 certified QMS by Intertek, ensuring the highest level of quality and service.



MANUFACTURING

From cable transition boxes and enclosures to bus bars and structural supports, Power Bus Way is prepared to handle any type of metal fabrication needed. We can create any piece to fit a project's custom dimensions and ensure total compatibility throughout the entire system. Best of all, we'll finish the job quickly with minimal turnaround time.

ENGINEERING

Our team of engineers check every item and aspect of a project so that the system is installed seamlessly. We use the latest technology, such as 3D modeling and BIM integration, to provide an unparalleled level of accuracy and visibility. Power Bus Way engineers are trained to conduct site surveys which prevents installation issues with interconnecting components.

RESEARCH & DEVELOPMENT

We believe in real world testing and conduct numerous tests and experiments to ensure compliance and optimum functionality. At our in-house lab, we conduct temperature rise tests, standards verification, and project specific testing. We have extensive experience with short circuit testing and have verified that our cable bus meets all fault current withstand requirements.



PROJECT EXECUTION

A

RFI (Request for Information)

Our application engineers will specify a solution that meets the needs of the RFI. A site visit will also be conducted if necessary.

B

RFQ (Request for Quotation)

A detailed quote with a bill of materials (BOM) and a general lead time for the drawings and delivery of system and equipment will be issued.

C

P/O Received

The order is assigned to a project manager and a site survey is scheduled. Site and equipment drawings will be requested from the client.

D

Site Survey / Field Measurements / 3D Scan

Our project manager and or lead designer will visit the site to conduct a survey and gather measurements. This may include a 3D scan of the environment.

COMMITMENT TO SERVICE

We are fully committed to all projects from start to finish and dedicated to customer service and support through every stage, ensuring the project stays in line with schedule and budget expectations.

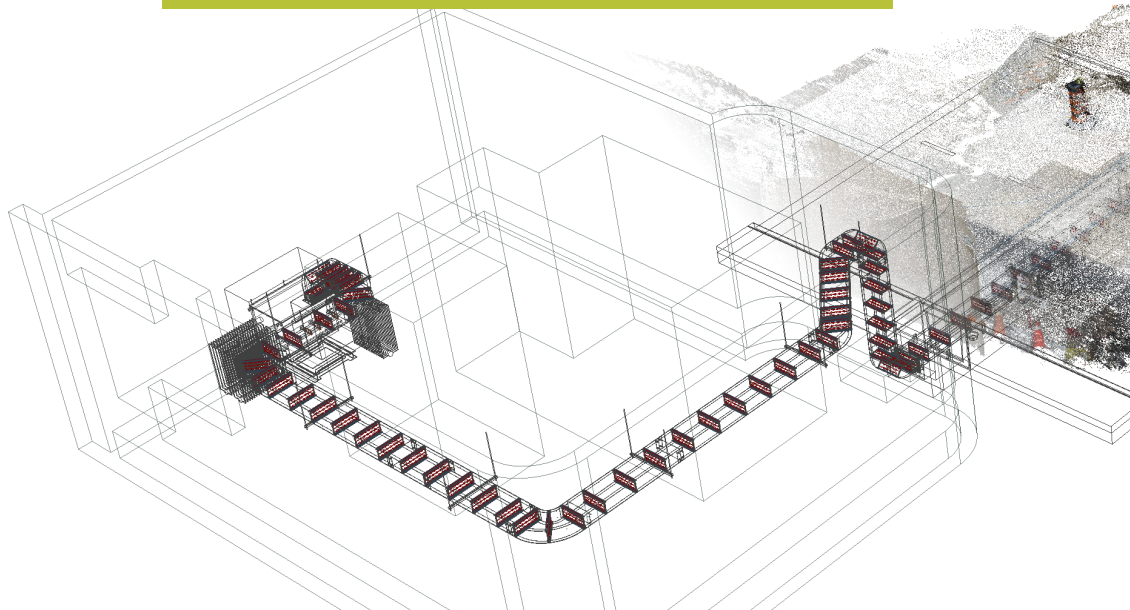

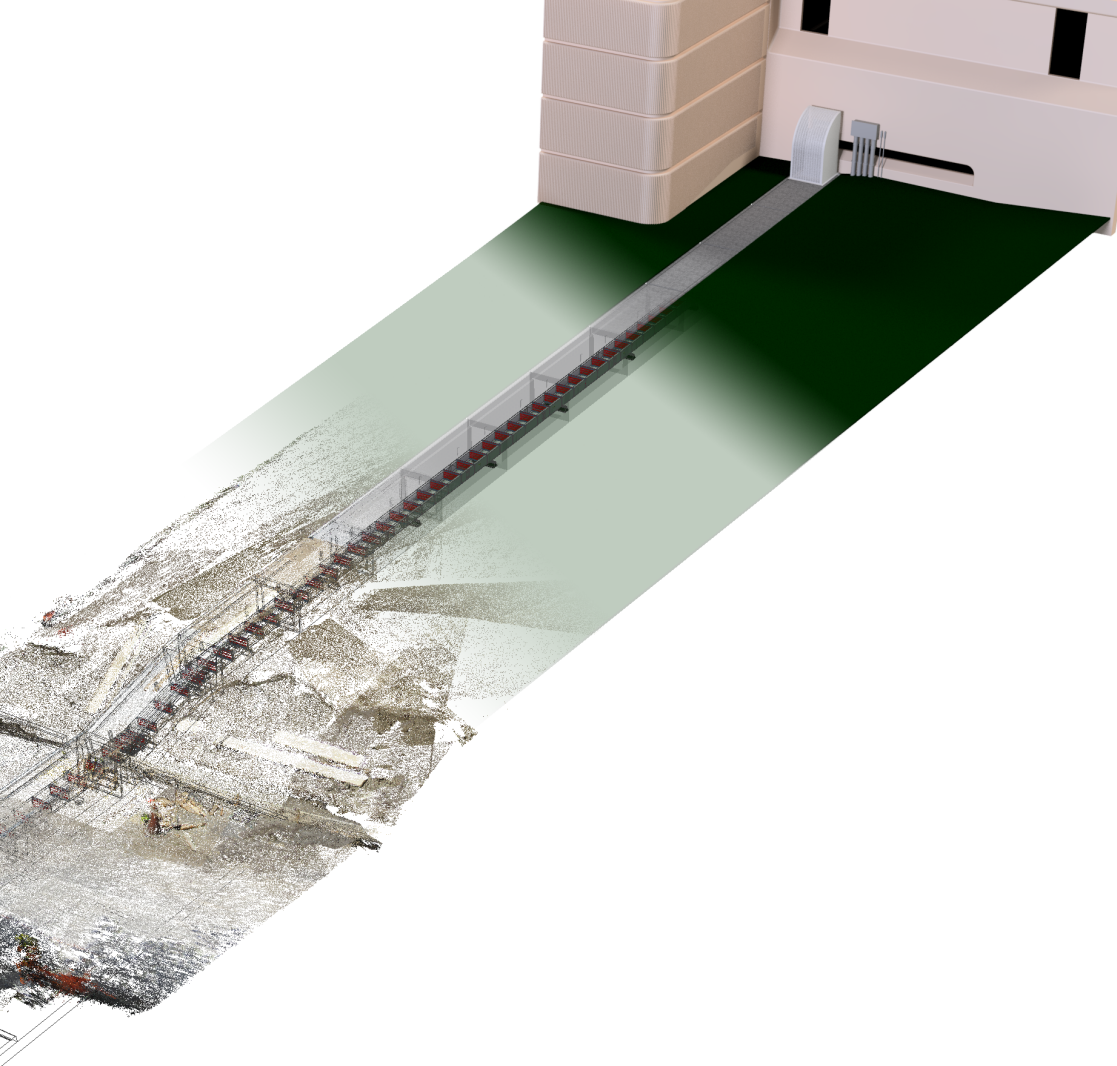
**E****Layout Design / Approval Drawings**

Our designer completes the layout and sends both drafts and final drawings for review and approval.

F**Drawings Approved**

After drawing approval, we issue a full set of manufacturing drawings and get the system into production. Once the manufacturing is complete, we conduct a quality inspection and ship to the site.

G**Product Arrival**

The system will arrive at the project site in accordance with the delivery schedule.

H**Installation (By Installer)**

Throughout the installation, we provide support to the installer. We can also supply on-site support (if required) to ensure a seamless, trouble free installation.

I**Commissioning (By Installer)**

We stand by our product throughout the installation and field testing process, supporting the installer until commissioning. In the rare event that adjustments and/or additional components are required, they will be provided in a timely manner.

9

POWER BUS WAY

COMMERCIAL/ INSTITUTIONAL



**F**

rom high rise buildings to underground trench systems below heavy vehicular traffic, Power Bus Way creates solutions for every situation.

We bring years of hands-on experience, working in both commercial and institutional facilities. This means we'll create power feeder systems that are safe, reliable, cost effective and aesthetically pleasing.

Power Bus Way cable bus systems are designed to fit a wide range of budgets. For example, systems can be outfitted with either aluminum or copper cables. Systems can also include tamper-proof hardware and/or be professionally painted to blend in with the surroundings.

“ This project was installed in far less time than anticipated and commissioning was done with minimum shutdown ”

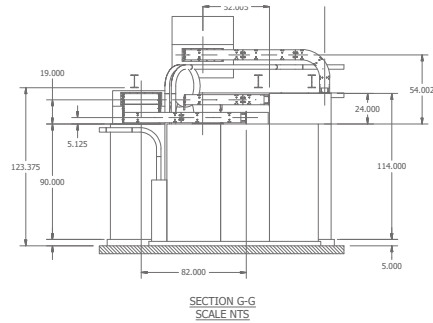

HIGH RISE BUILDING

600V, 1600A Vertical riser through 26 floors

As a retrofit installation, the client required an urgent turnaround for this high-rise cable bus system. Our engineers arrived on site to carry out surveys and took field measurements. The client began receiving components on site within one week.

This cable bus design had to overcome numerous challenges, such as tight space constraints through floor penetrations and difficult to access areas. Notable features included intermittent tap boxes at various floors and a unique clamping mechanism that distributed the weight evenly across the entire vertical length of the cable bus. This solution minimized the need for structural supports.

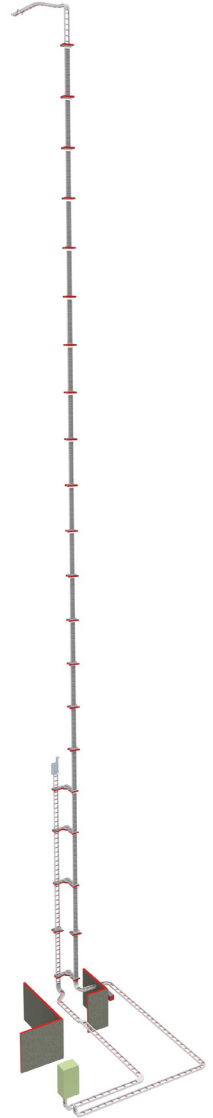

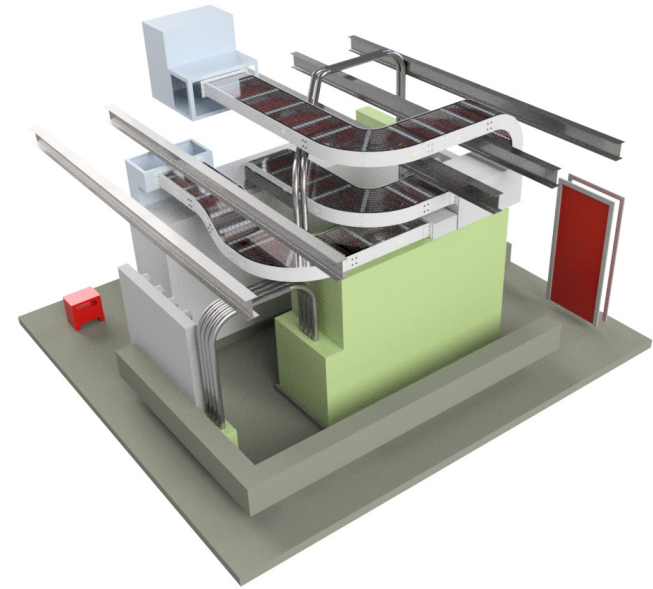
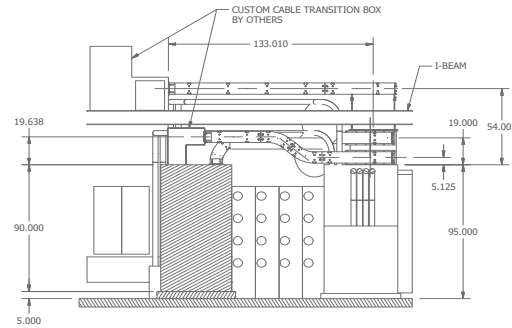

For quotes, contact
sales-info@powerbusway.com

RETAIL MALL

600V, 3000A, 8 individual runs

In this project, multiple Power Bus Way cable bus systems were connected from distribution panels to Motor Control Centers with a variety of obstacles to overcome.

Bus ducts, conduits, and support structures all had the potential to interfere with the cable bus system. However, we were able to take the client's Building Information Model (BIM) and use it to map out the path of least interference for the cable bus system, avoiding potential problems during installation.



“ It is vital to use the latest tools to ensure that our systems fit right, every time - the first time. We use everything from 3D site scanning to BIM technology guaranteeing the best possible results for each of our clients. ”

GENERAL HOSPITAL

600V, 2000A, 432 ft, Underground installation

As part of their renovations, Etobicoke General Hospital required a new cable bus system to guarantee a reliable supply of power at all times. To ensure that the installation could be executed without problems, we used 3D scanning technology to survey the surrounding area. By doing so, we were able to identify potential obstacles and map the best and safest route for the cable bus.

Result: A customized, road-grade, precast concrete trench was installed for the hospital without any issues. Custom protective shrouds and cable transition boxes were also supplied.

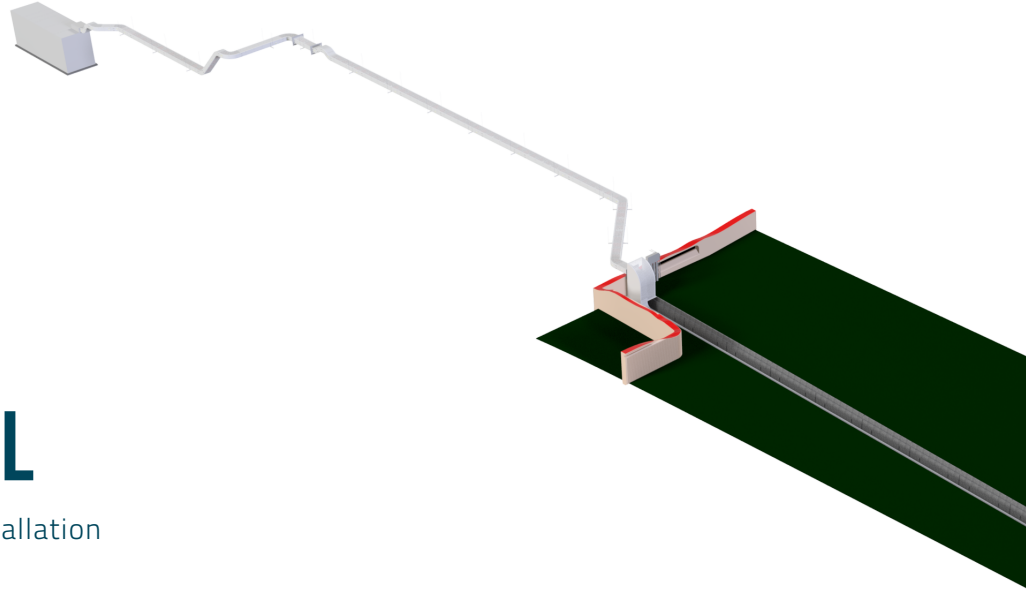

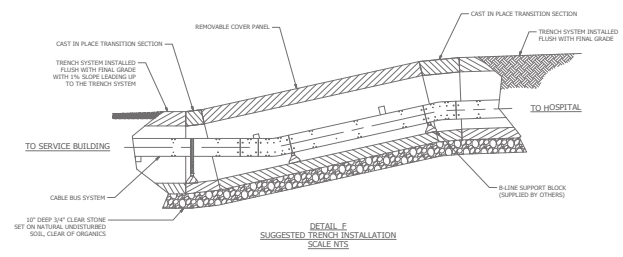
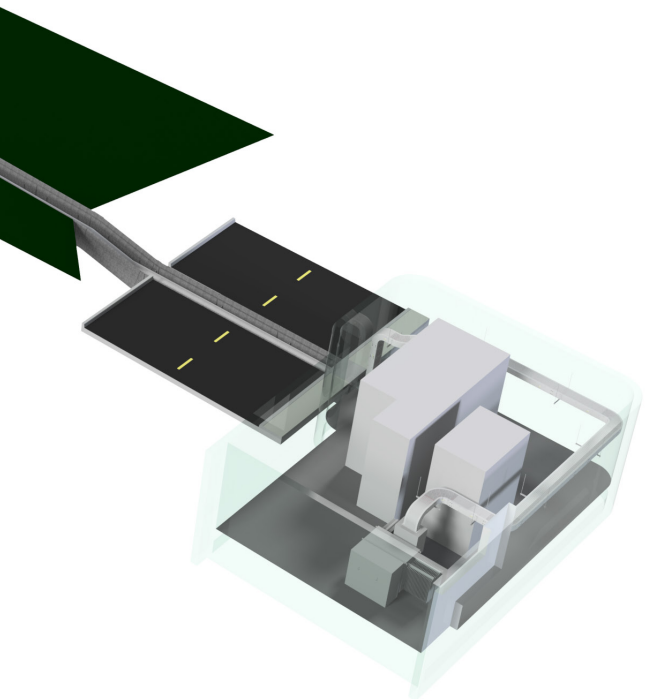
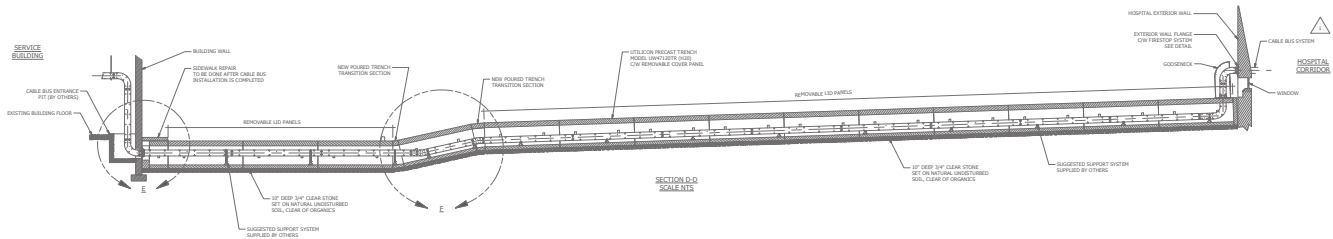

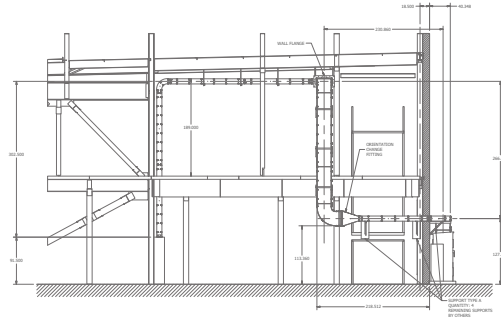

RETAIL DEPARTMENT STORE

600V, 3000A, Painted

F

or this project, the client needed their Power Bus Way cable bus system to be painted to color match the walls of their retail space. We delivered an exact match. We also imported the client's BIM model into our own design software enabling the cable bus to navigate around existing services and equipment.

In commercial settings, aesthetics of a cable bus system can be very important. Our cable bus enclosures can be painted in any color to ensure it blends with the surroundings.

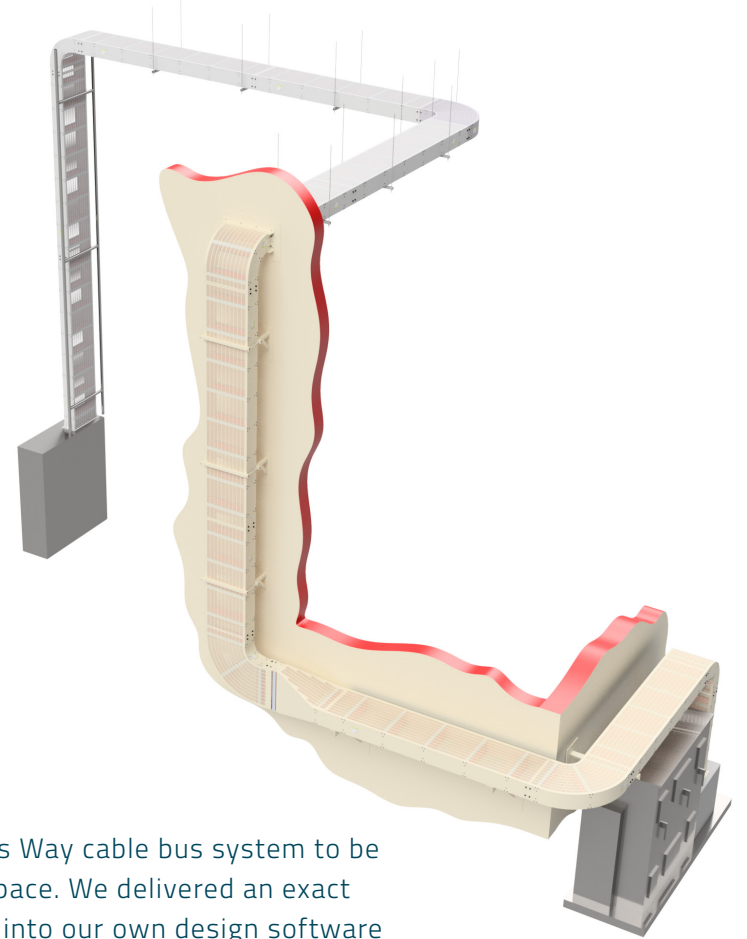



DATA CENTERS



**F**

or data centers, downtime is costly. Therefore, Power Bus Way cable bus is the number one choice for the reliable transfer of on-demand power from backup generators.

Power Bus Way cable bus can:

- connect directly to diesel generators
- achieve immediate startup without concern of a flashover
- reduce the number of conductors without the need for armored cables
- provide a smaller footprint



DATA PROCESSING CENTER

600V, 3200A, 3000A, 2500A, 1707ft total length, 11 individual runs

T

his client's data center incorporated multiple complex runs that connected between generators and switchgear. The lengthy runs ran over rooftops and spanned separate buildings. By using our 3D modeling software, we were able to configure the cable bus to fit within the exact route and the confined spaces of the electrical room.

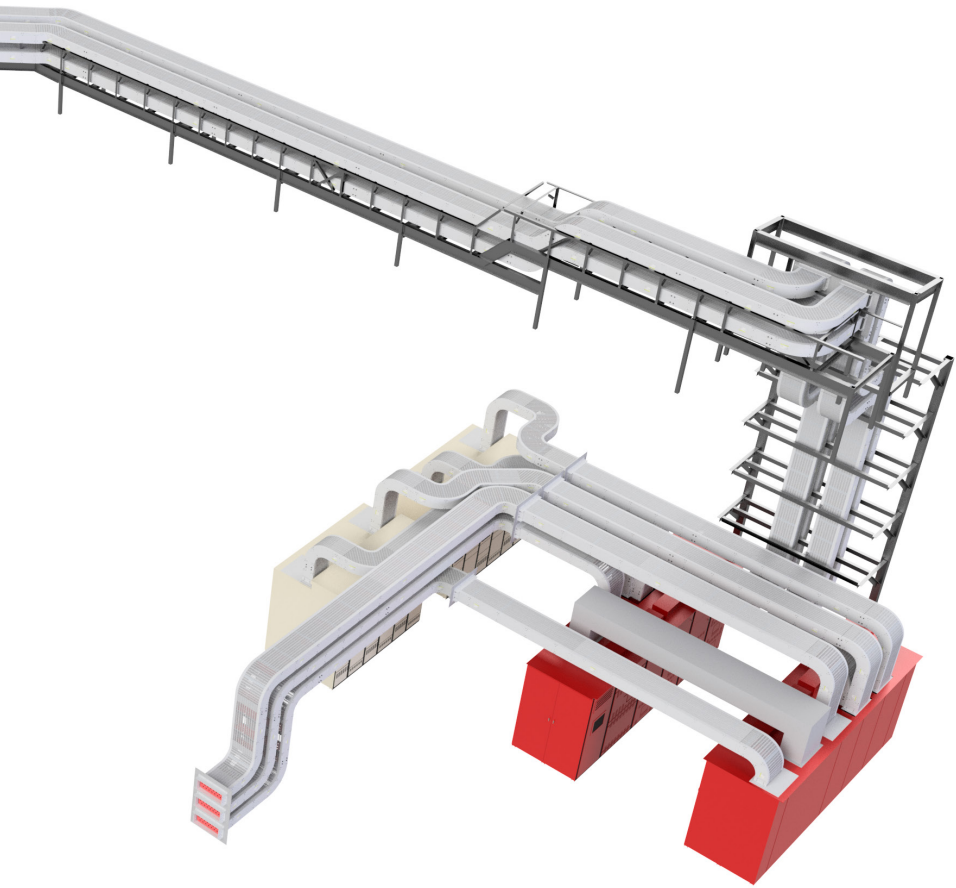

“ The client was very pleased with the quality of product & ease of installation. Power Bus Way is now specified for all new and retrofit work for all of the client’s sites. ”

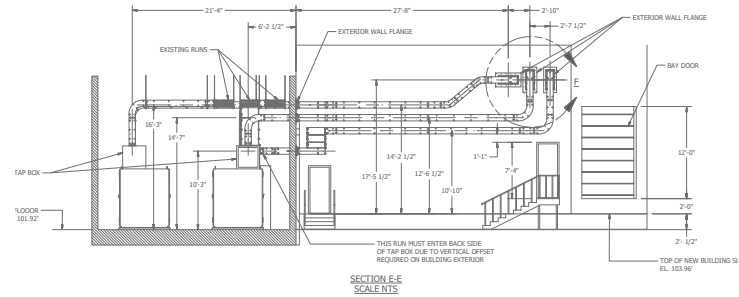

Power Bus Way cable bus model placed into 3D Scan point cloud

INFORMATION SERVICES & IT CENTER

480V, 4000A, 1100ft total length, 13 individual runs

W

e used the latest 3D scanning technology when mapping out possibilities for this client. The approach enabled existing structures to be identified and alternative routes to be investigated. As a result, there were no problems or interferences and the contractor was able to install the cable bus quickly and efficiently.

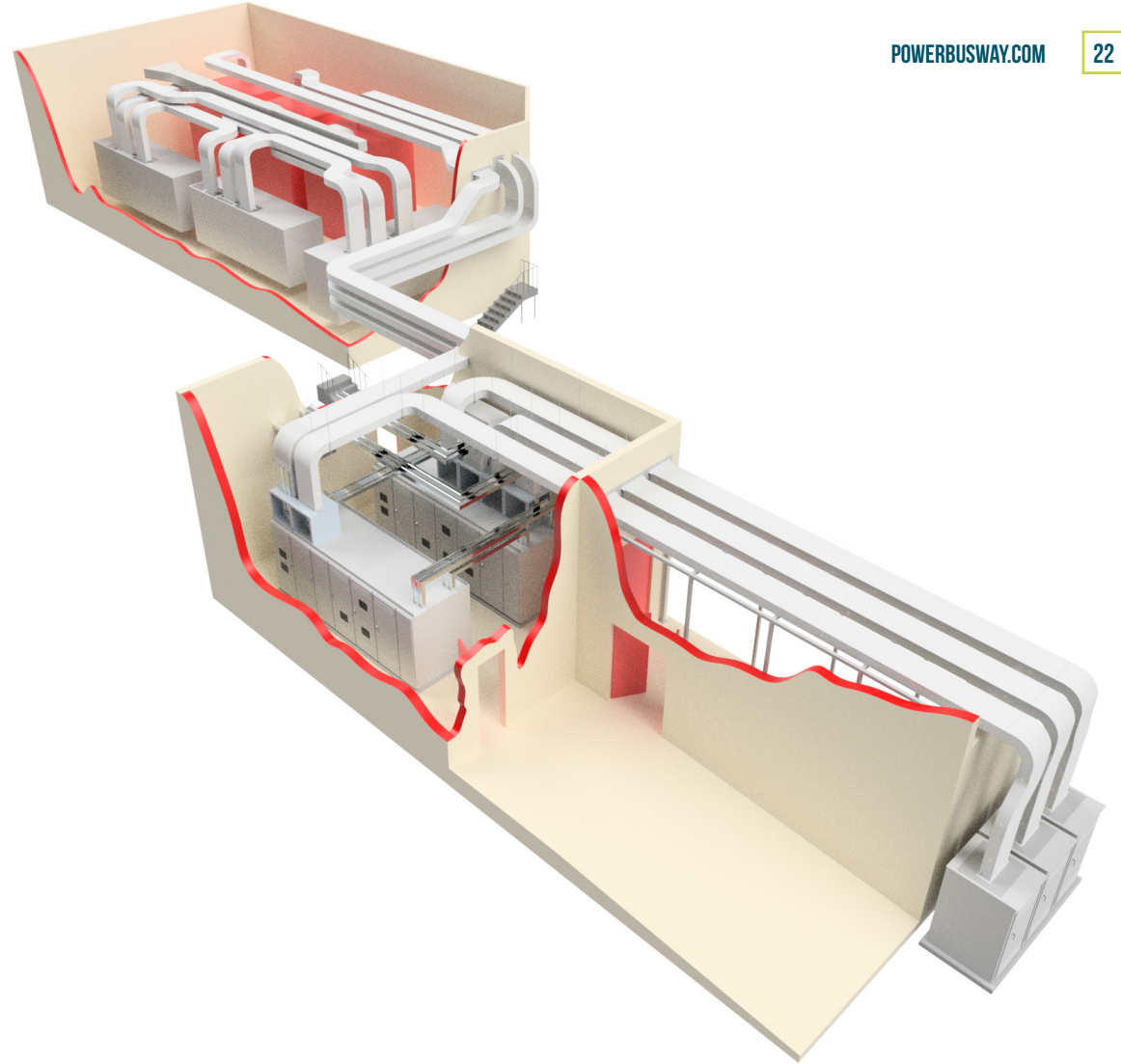
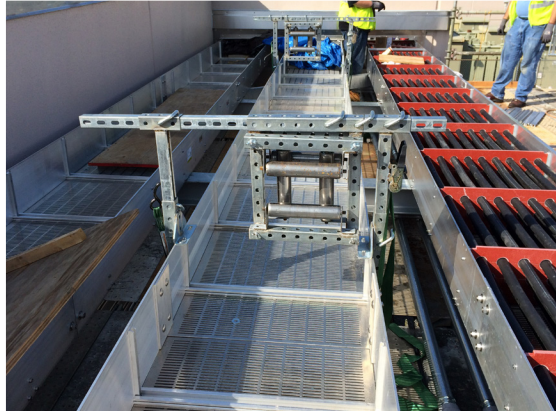

DATA CENTER

600V, 3200A, 500ft total length, 3 individual runs

For this client, the cable bus runs were installed in a cast-in-place underground concrete tunnel. As the project manager, we took precise field measurements to ensure accurate construction of the concrete tunnel while also designing the layout of the cable bus system.

Our team coordinated the electrical and civil contractors as well as the mechanical and electrical engineers who were also working on the project. Prior to its completion, Power Bus Way conducted heat run testing to confirm that the entire system would operate at its optimum performance.

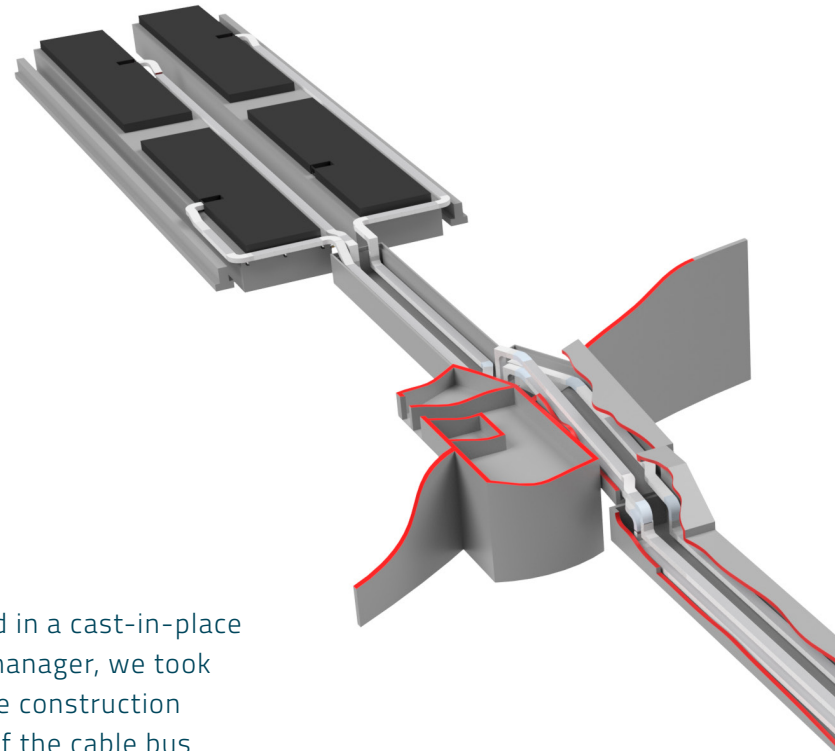

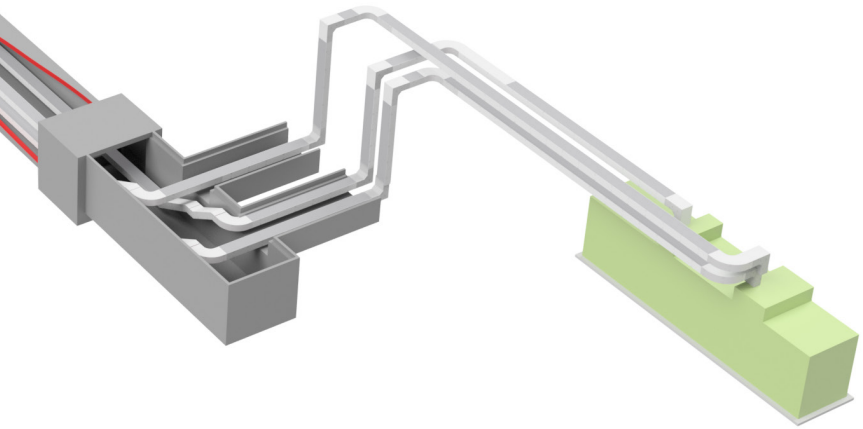
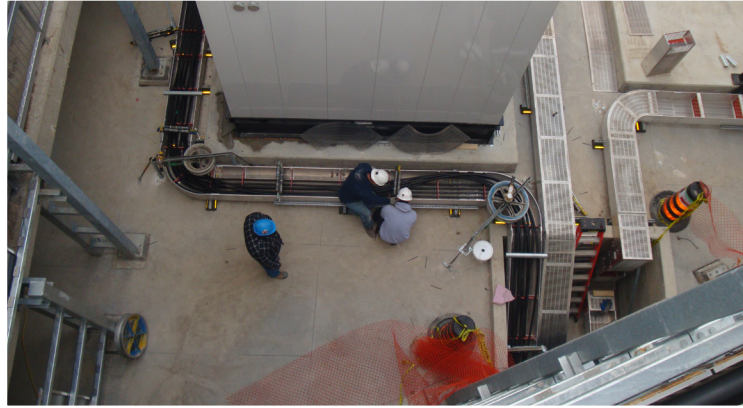

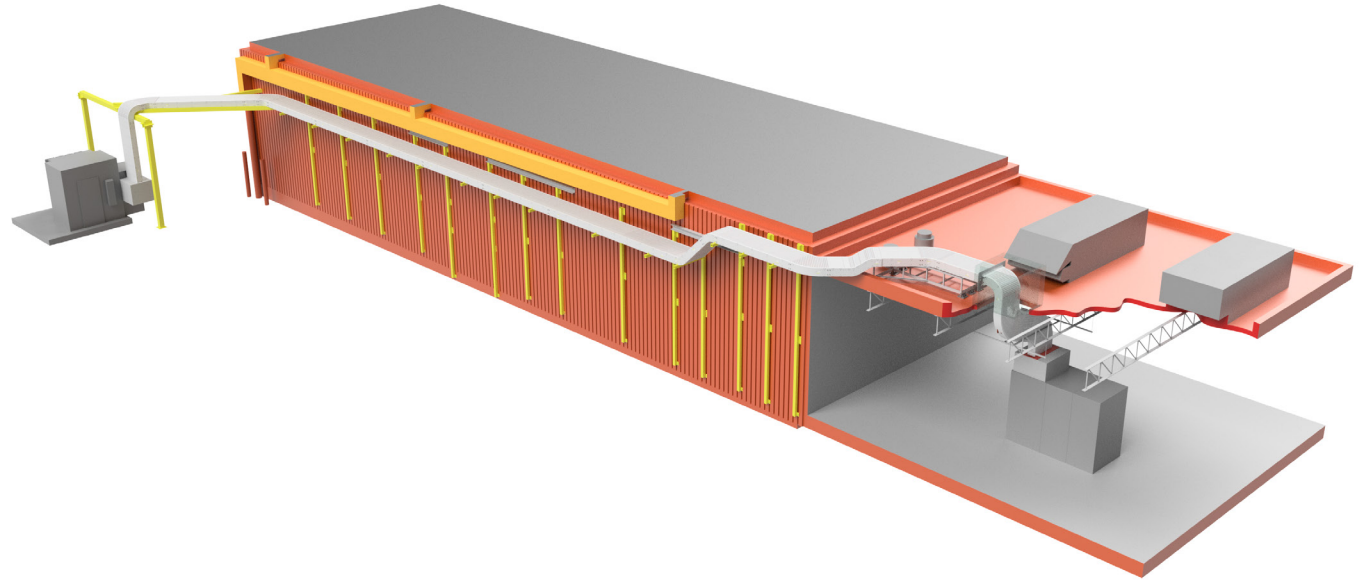

TELECOMMUNICATIONS HUB

600V, 5000A, 160ft

The Power Bus Way team actively managed all aspects of this extensive cable bus project, including acting as a liaison between the general and electrical contractors. As part of this project, our personnel also designed, manufactured and delivered custom structural engineered cable bus supports. This design-to-delivery service is unique to Power Bus Way.



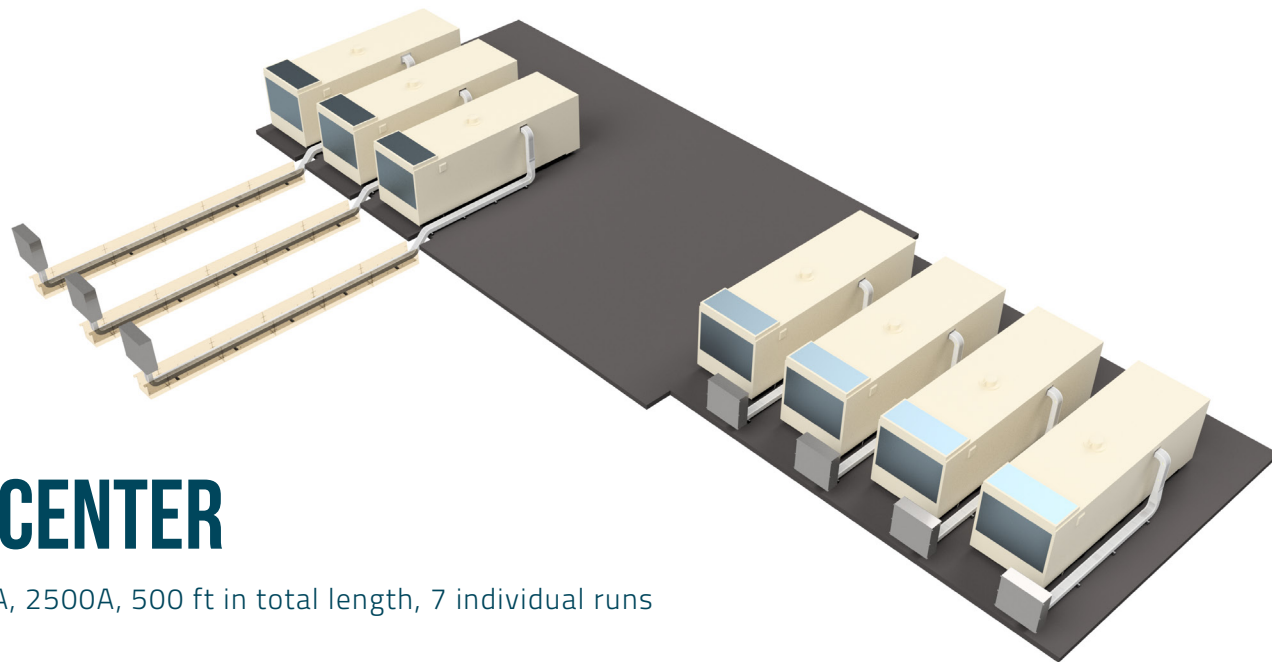

DATA CENTER

600V, 2000A, 2500A, 500 ft in total length, 7 individual runs

Power Bus Way cable buses were used to transfer power between generators and tap boxes. In this project, 3 out of the 7 runs were installed in precast concrete trenches. In addition, vertical transition fittings were used throughout this project. These fittings enabled the cable bus orientation to be easily changed while reducing its overall footprint.



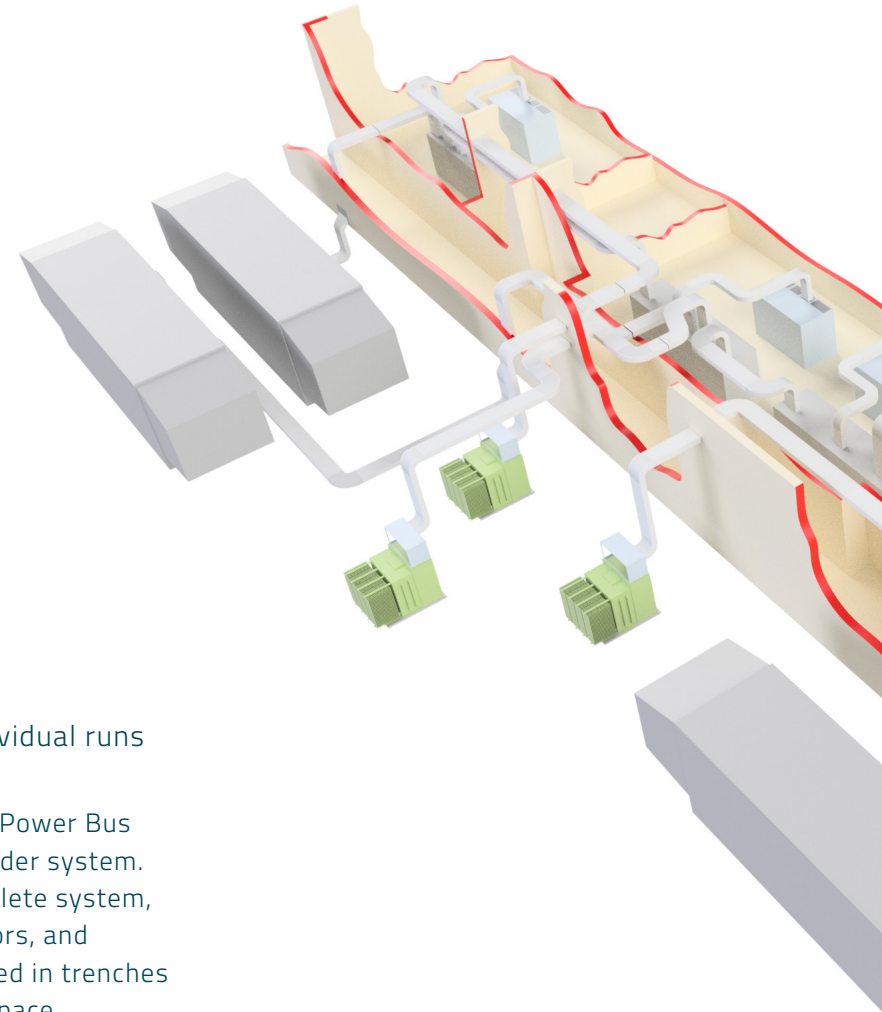
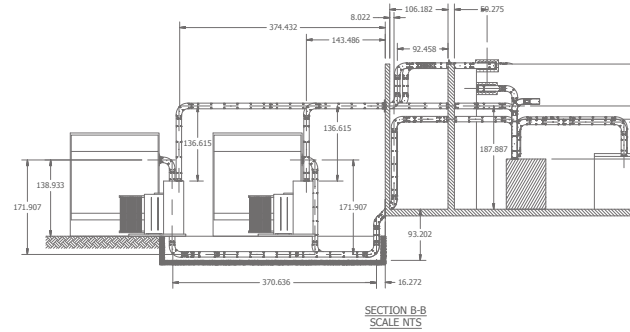

DATA CENTER

600V, 3000A, 4000A, 1198ft total length, 13 individual runs

In this project, the client specified the use of Power Bus Way's cable bus for their entire electrical feeder system. Our engineers designed and supplied a complete system, including connections between transformers, generators, and switchboards. Several cable bus runs were also installed in trenches and custom angled wall flanges were used to reduce space.

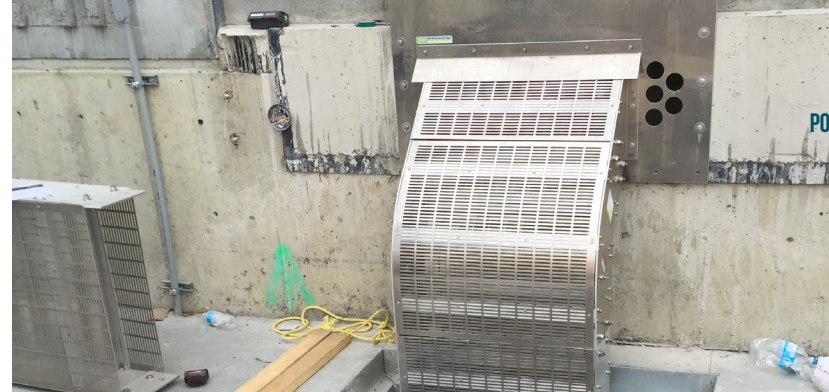
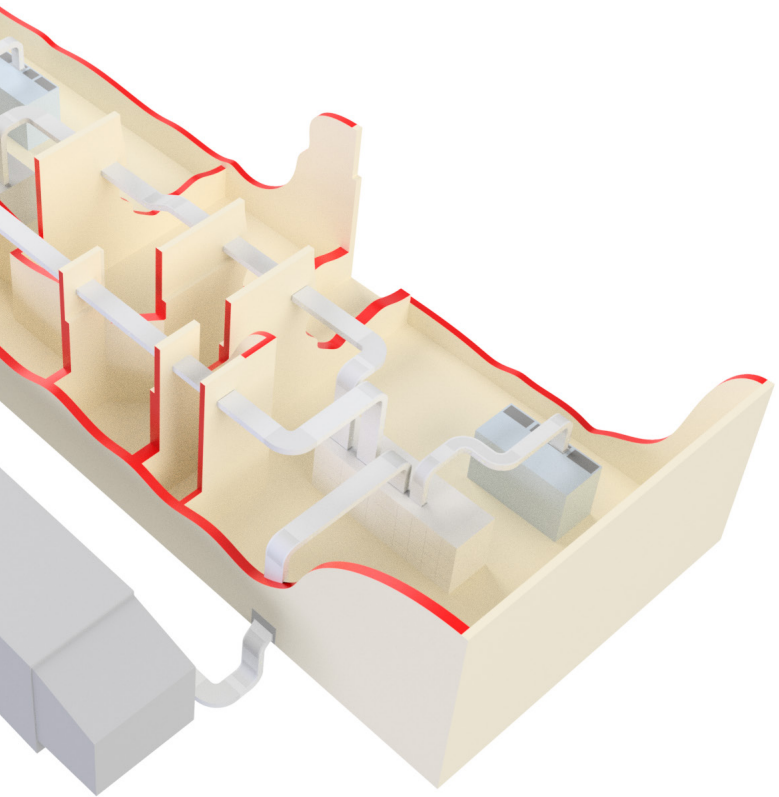

OIL AND GAS





Oil and gas sites experience some of the harshest environmental conditions. Fortunately, the robust NEMA and CSA certified heavy duty enclosures ensure the cables are protected.

Enclosures can be manufactured with various combination of metals to withstand the most hazardous conditions. What's more, power cables can be supplied with specialized cold weather jackets that are capable of withstanding extreme temperatures.

Power Bus Way doesn't just provide cable bus; we design and manufacture custom top hats, transition, and bus tap boxes that will suit any condition.

NATURAL GAS FRAC SITE

600V, 3000A main with 1000A branch feeders

This project is the perfect example to showcase the durability and flexibility of our cable bus systems. We've designed a system to feed a large current load from a generator through a custom splitter box, evenly distributing the load to multiple cable bus feeders. We also imported the client's Building Integration Model (BIM) into our design software for the successful navigation of the cable bus around existing equipment and services.

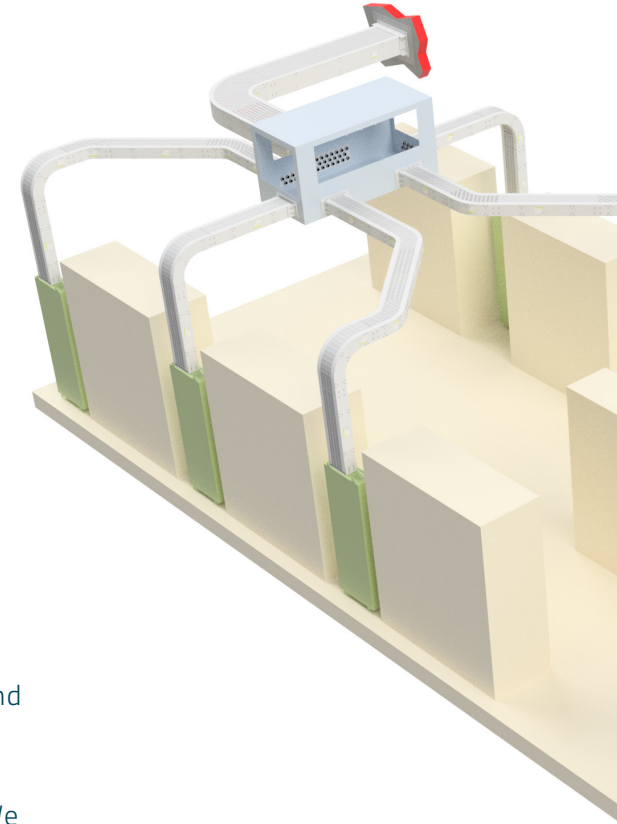

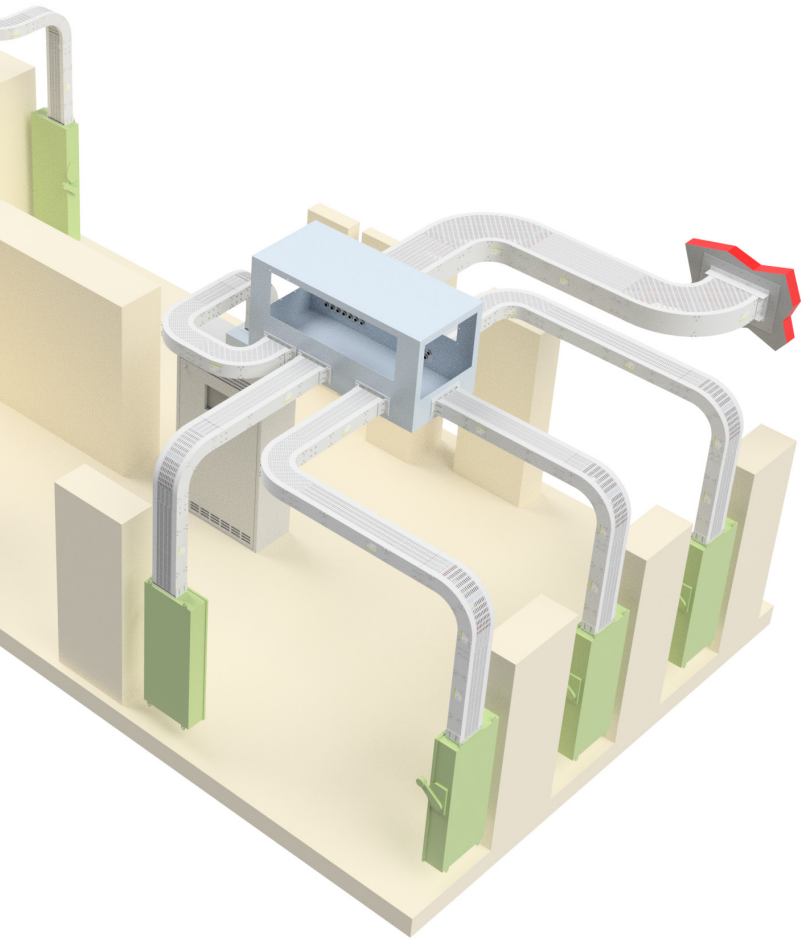

Power Bus Way cable bus fully complies to all NEC and CE Code requirements and is certified to the CSA C22.2 No. 273-14 standard.



GAS PLANT

600V, 2500A, 2 individual runs

In many cases, a client contracts a third party consulting firm to design the route for their cable bus system – as was the case in this project. Our designers collaborated with the consultant to provide the most cost-effective system to transform the client's vision into reality!



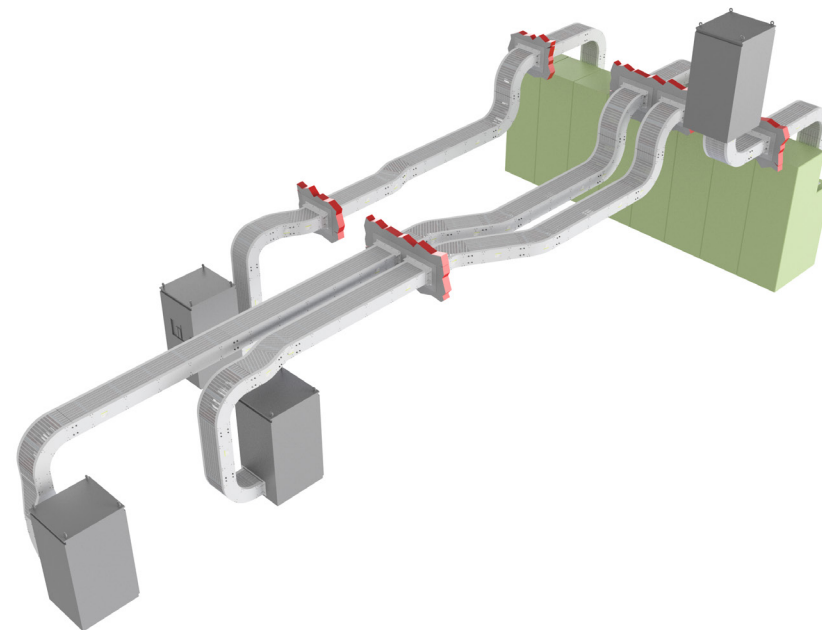
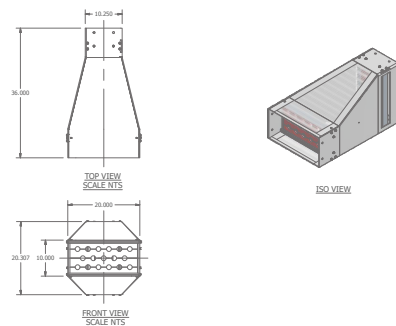

GAS PLANT

600V, 2500A, 4 individual runs

T

his project included the use of an orientation change fitting (OCF) to accommodate the restricted space, minimizing the cable bus footprint.

POWER GENERATION





With a long tradition of serving the power generation industry, Power Bus Way understands the need to reduce outage times and provide a lengthy equipment service life. This is why we've created our cable bus systems to ensure continued operation where alternative systems would fail. It's also why cable bus is recognized as one of the longest lasting power distribution systems in the industry.

We know that some repairs or situations may be urgent. That's why Power Bus Way will design and manufacture a system and all necessary components in a quick and efficient manner.

For maximum efficiency and to minimize downtime, the cable bus was preassembled prior to arriving on site and craned in place in less than one hour.

POWER GENERATING STATION

13.8kV, 2000A (upgradeable to 3000A), 7 individual runs

F

or this project, 3D scanning technology was used to identify obstacles within the client's structure, identify a route, and avoid installation issues.

We designed and supplied seven 15kV cable bus systems. Five of the seven runs were created with additional space within the enclosure to accommodate a future load increase.

For maximum efficiency and to minimize downtime, the cable bus was preassembled prior to arriving on site and was craned in place in less than one hour.

The client was extremely pleased with the results. They have opted to use Power Bus Way cable bus to replace their existing bus ducts in the future.

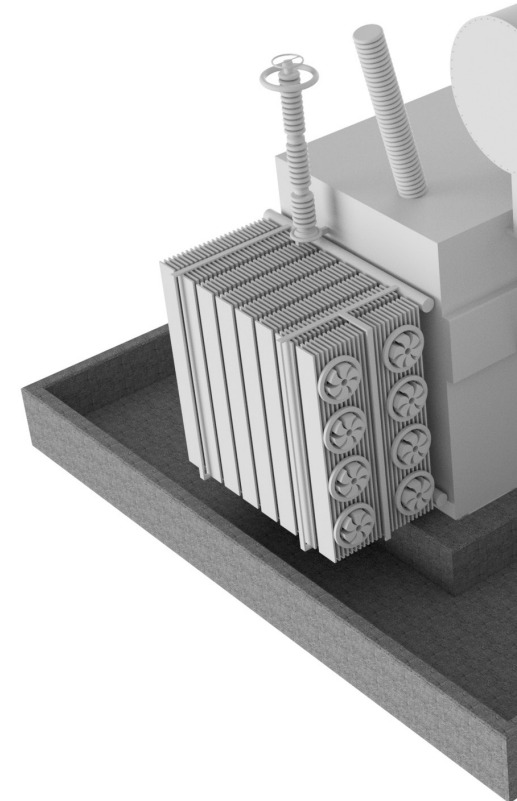

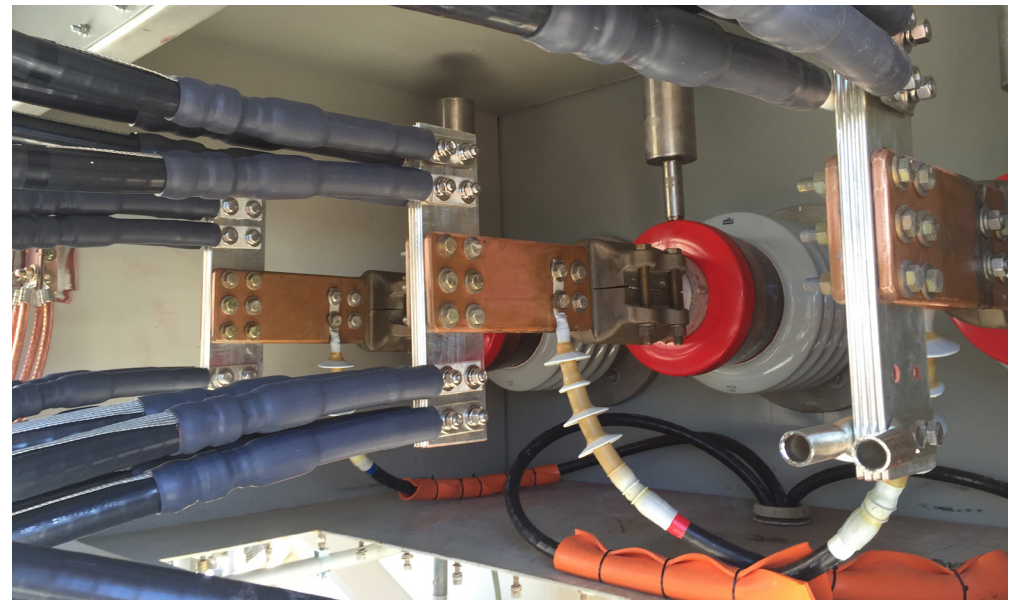
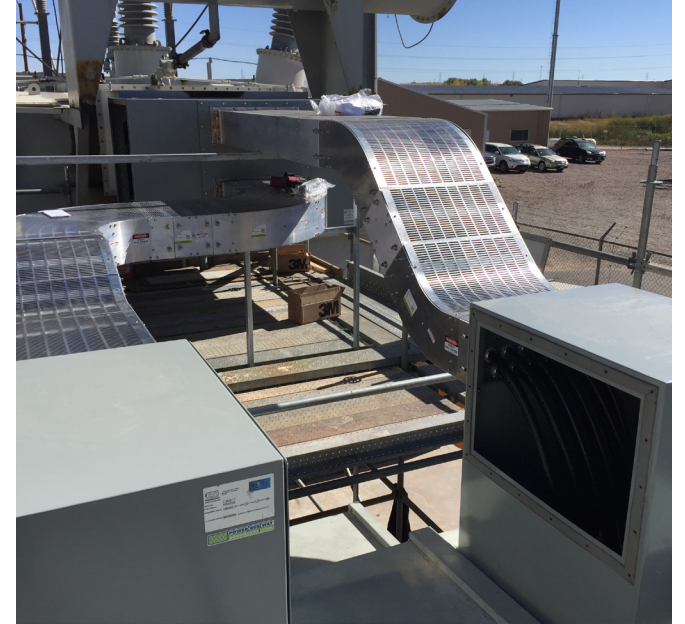
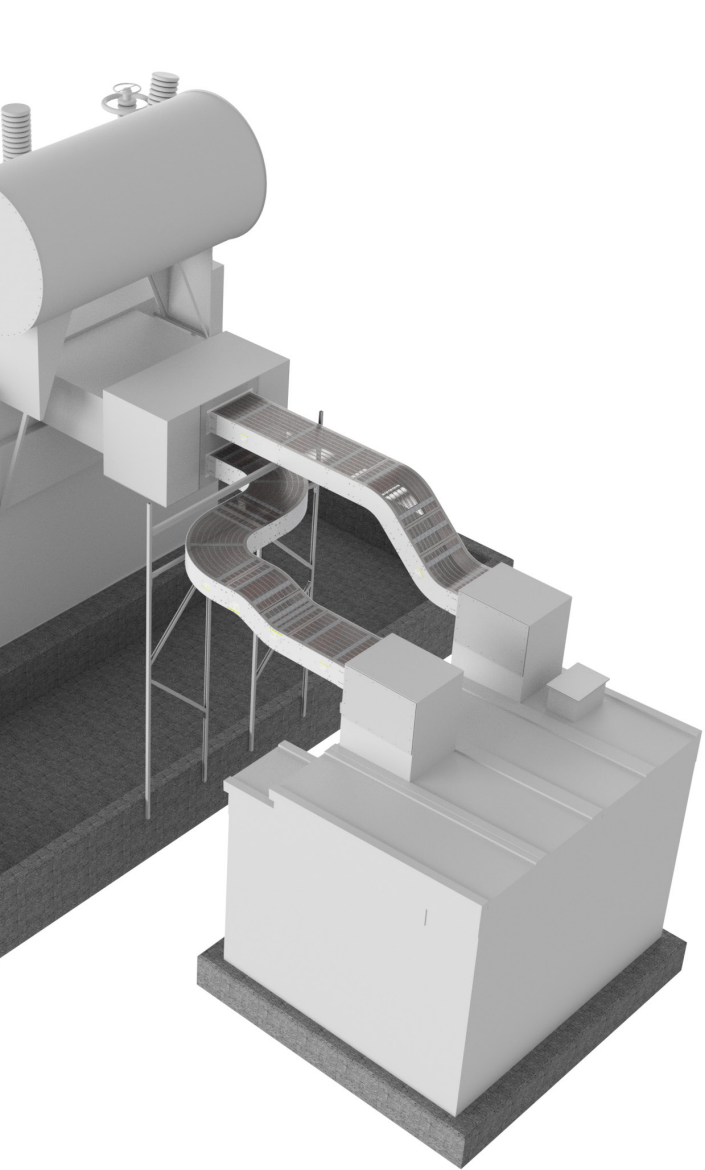

“

A below grade cable bus is an excellent way to tuck away a feeder system while still allowing direct access for visual inspections.

”

POWER GENERATING STATION

4.16kV, 4000A, 2 individual runs

For this generating station, Power Bus Way designed a cast-in-place trench system for optimal performance, protection, and support. The project scope included supplying two 5kV, 4000A cable bus systems to run between the generator switchgear and GSU transformers, and removable heavy vehicle traffic rated (HS20) covers.

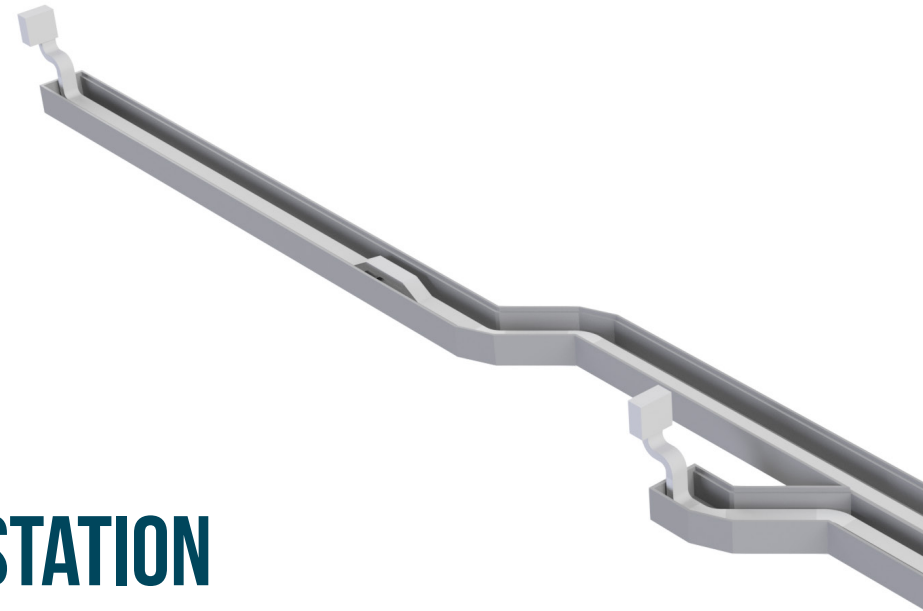

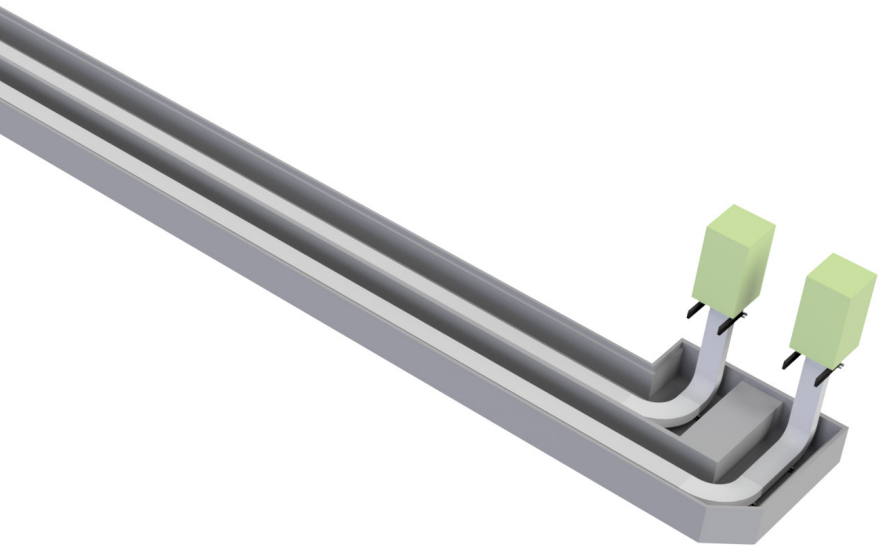
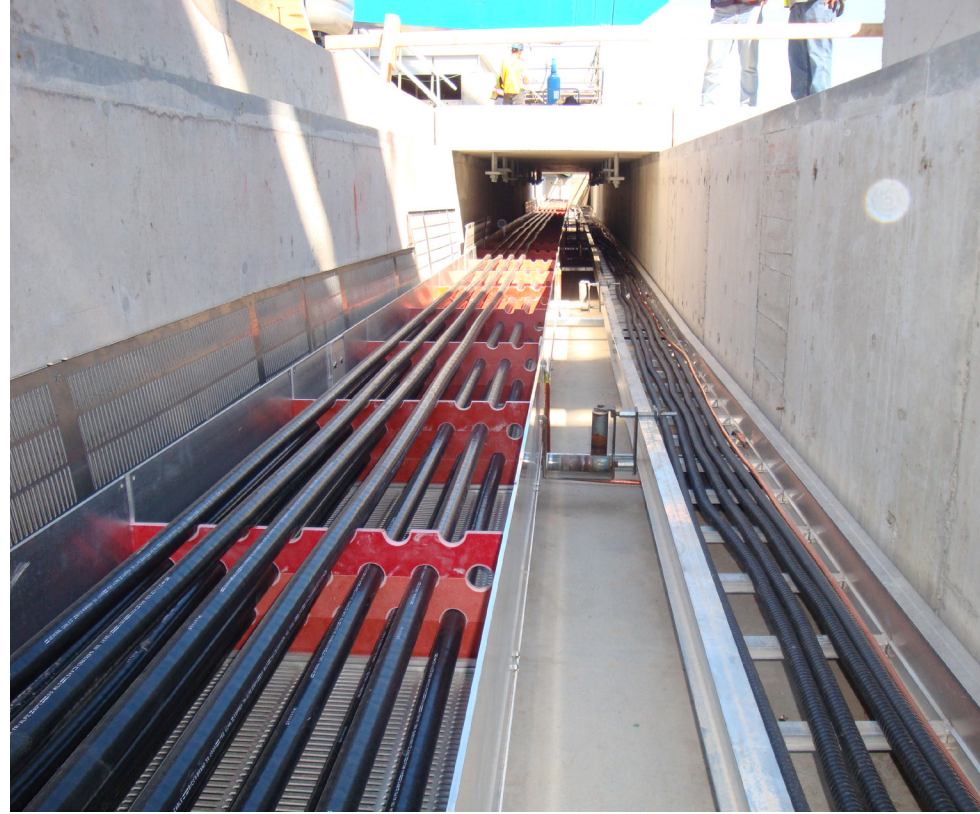
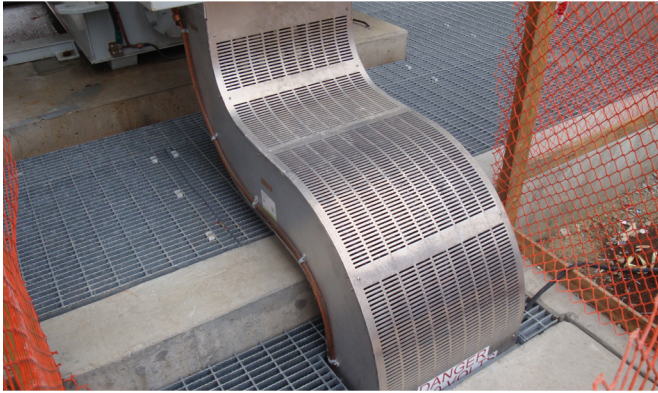

41

POWER BUS WAY

INDUSTRIAL



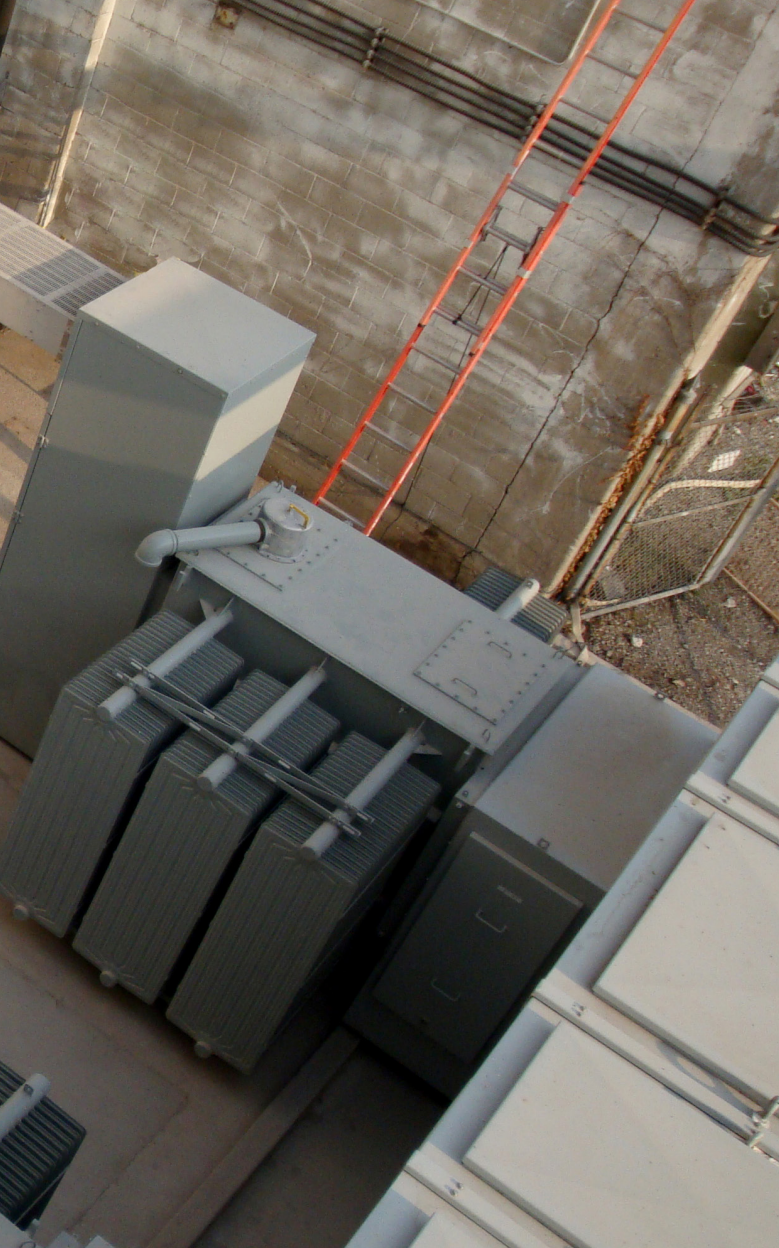

Industrial sites are not only harsh, they can also be incredibly dusty and/or caustic. Our cable bus systems are designed and manufactured to withstand these conditions, making our product an excellent choice for industrial environments.

Power Bus Way cable bus systems can run in close proximity to steel mill processing lines and blast furnaces without effecting efficiency. Our team will account for voltage drop over long distances and abnormal ambient temperatures during the design phase.



STANDBY BUS DUCT REPLACEMENT

600V, 1600A, 1669ft total length, 18 individual runs

A

special feature of this large cable bus project was the customized bus bar adaptors fabricated to connect the cable bus to existing bus duct feeders. Power Bus Way also utilized orientation change fittings (OCF) to reduce the footprint of the cable bus while maintaining access for alterations and upgrades.

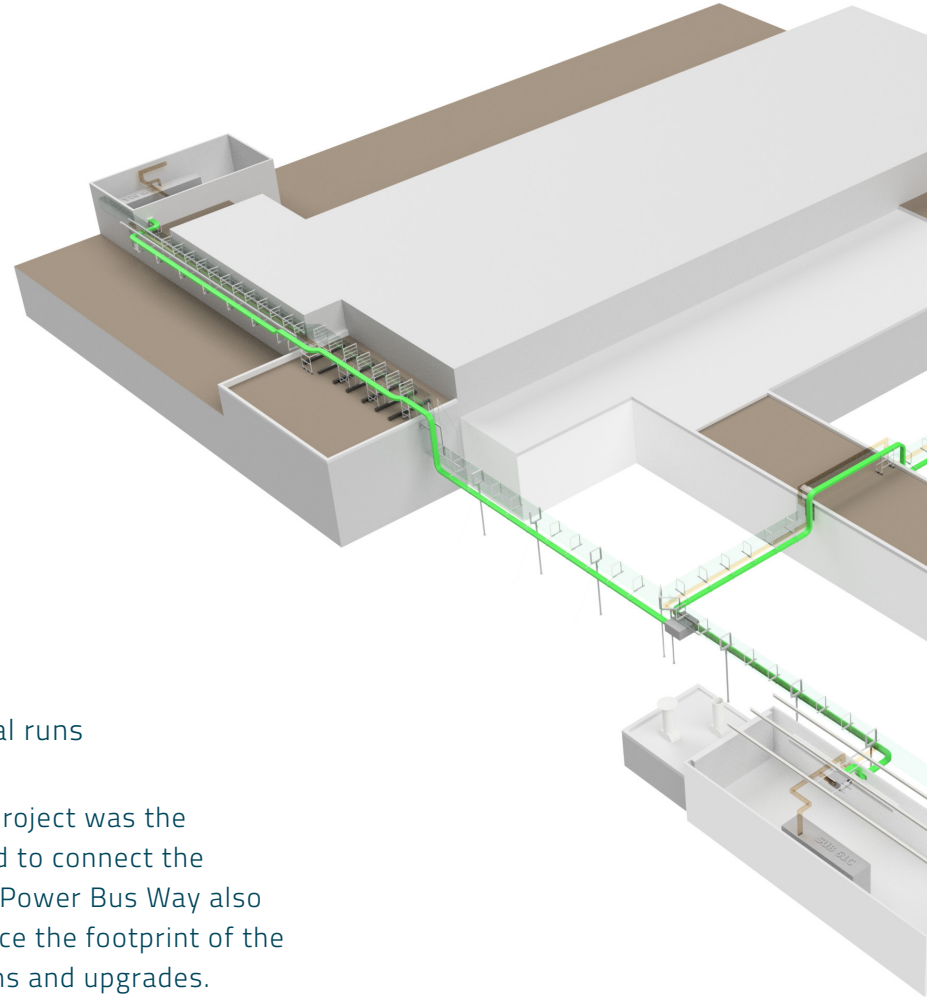

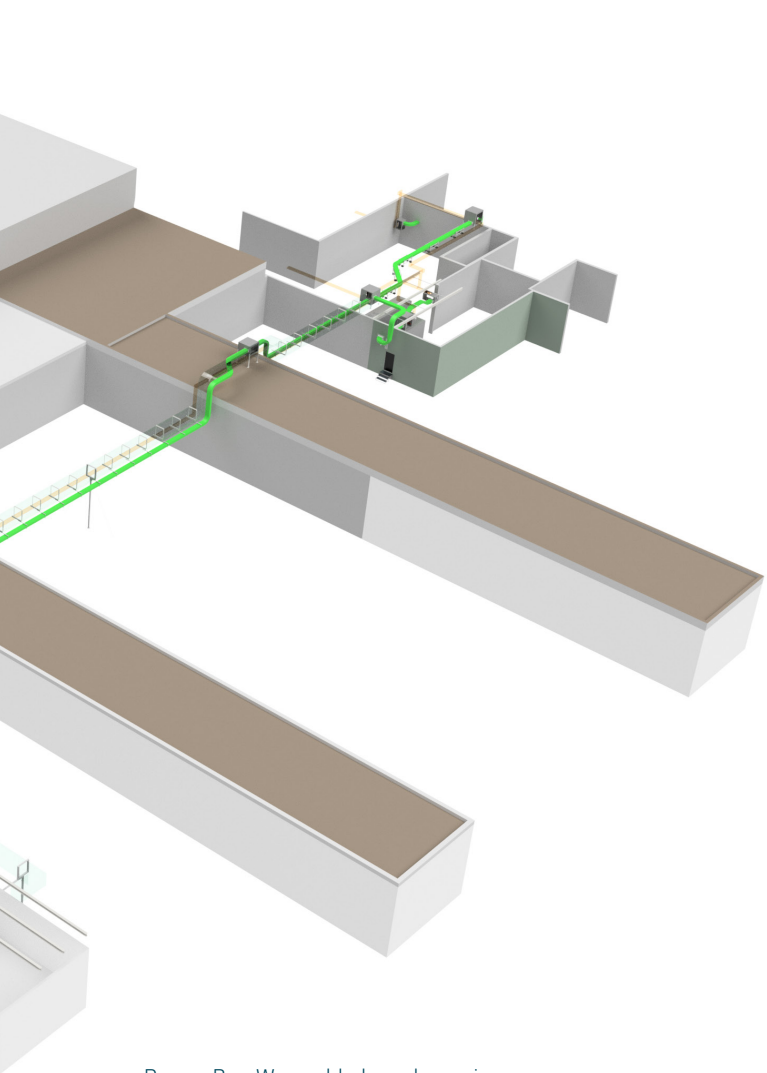

Power Bus Way cable bus shown in green



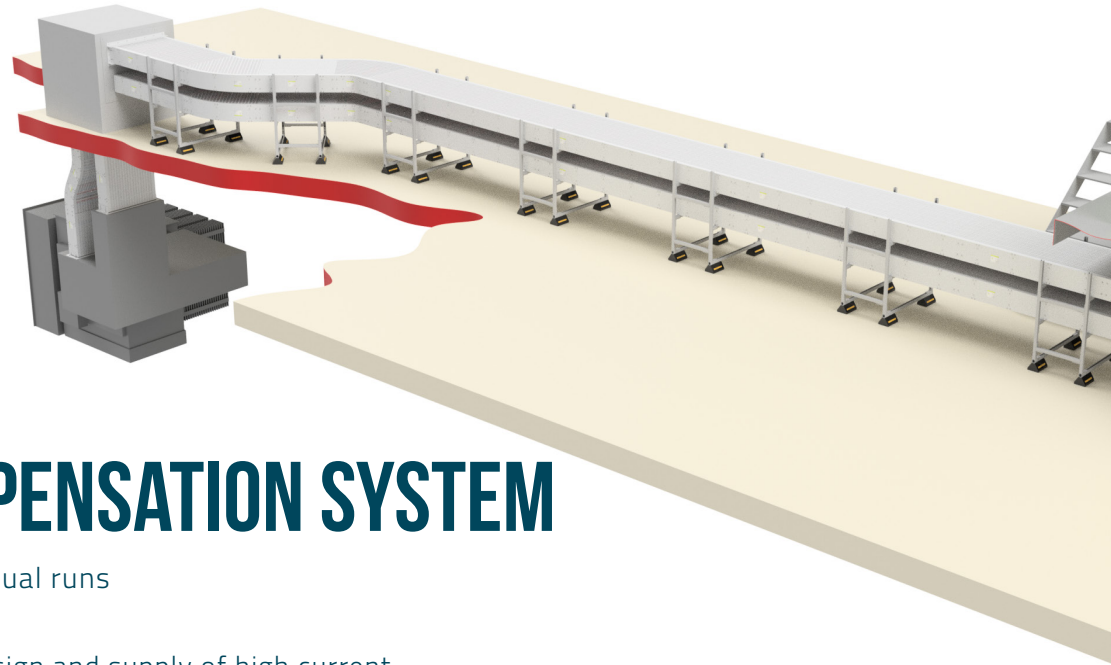

VOLTAGE COMPENSATION SYSTEM

600V, 5000A, 6000A, 2 individual runs

T

his project involved design and supply of high current 5000A & 6000A feeders. Power Bus Way also designed and supplied the rooftop supports, providing a sturdy base with the smallest footprint possible.

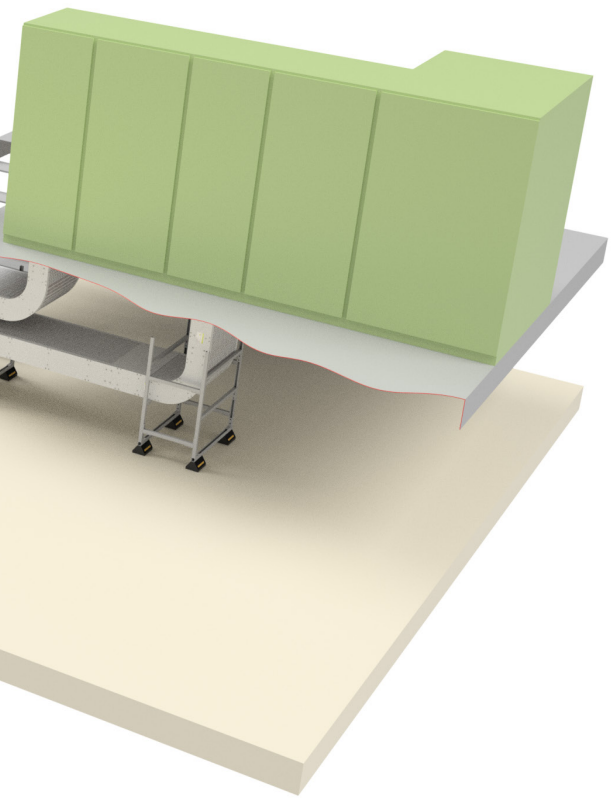

Power Bus Way cable bus systems are also available powder coated or in stainless steel to handle the harshest environments.

PRECIOUS METALS REFINERY

50V & 60V DC, 2200A per electroplating line. 5 circuits per busway

Power Bus Way designed and supplied a DC cable bus feeder system for an electroplating line, complete with rectifier termination boxes (including buswork) and ceiling mounted transition compartments for DC load connections.

The cable bus was powder coated to provide durable protection against harmful chemicals. Our flexible yet rugged cable bus system was the perfect match for this confined and corrosive environment.

Power Bus Way incorporated the client's BIM models to successfully navigate the cable bus and prevent interference with existing structural components.

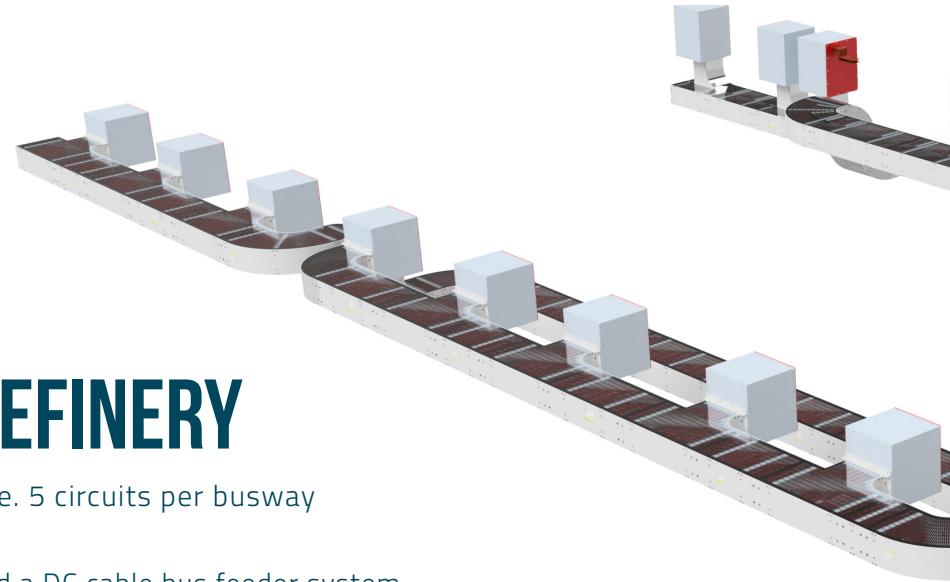

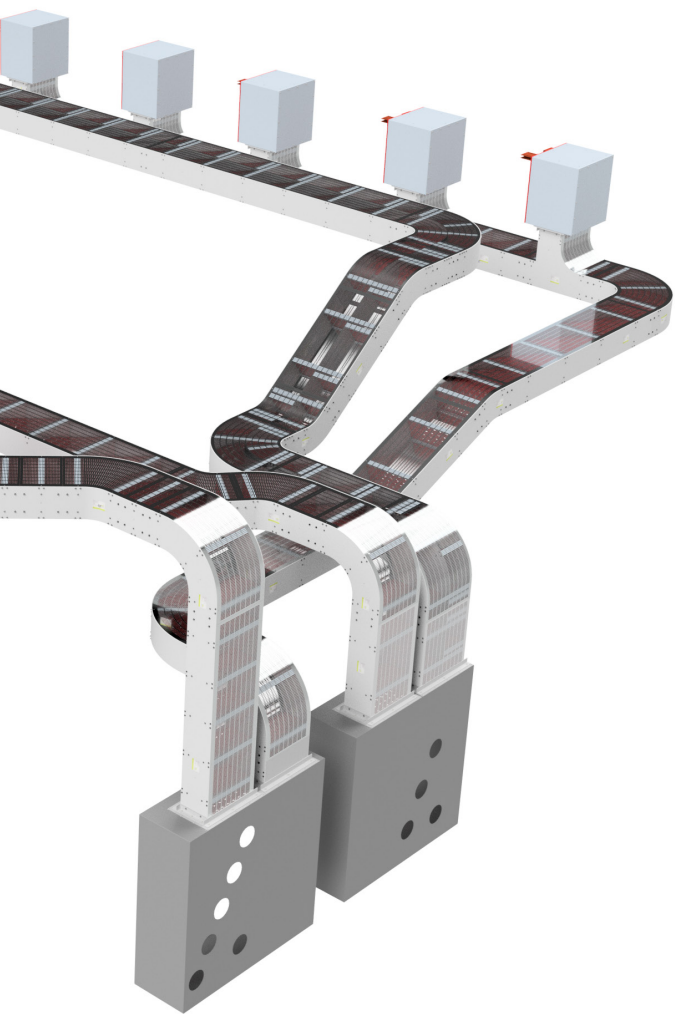

RENEWABLE ENERGIES





P

ower Bus Way is well equipped to tackle the unique challenges that come with the rapidly evolving renewable energy industry. We have created and tested enclosures to withstand the impact of falling ice from wind turbines, mass produced customized feeders for solar projects, and much more.

In each case, we worked with system integrators, creating reliable and cost-effective solutions that handle the unpredictable tendencies of wind and solar energy sources.~

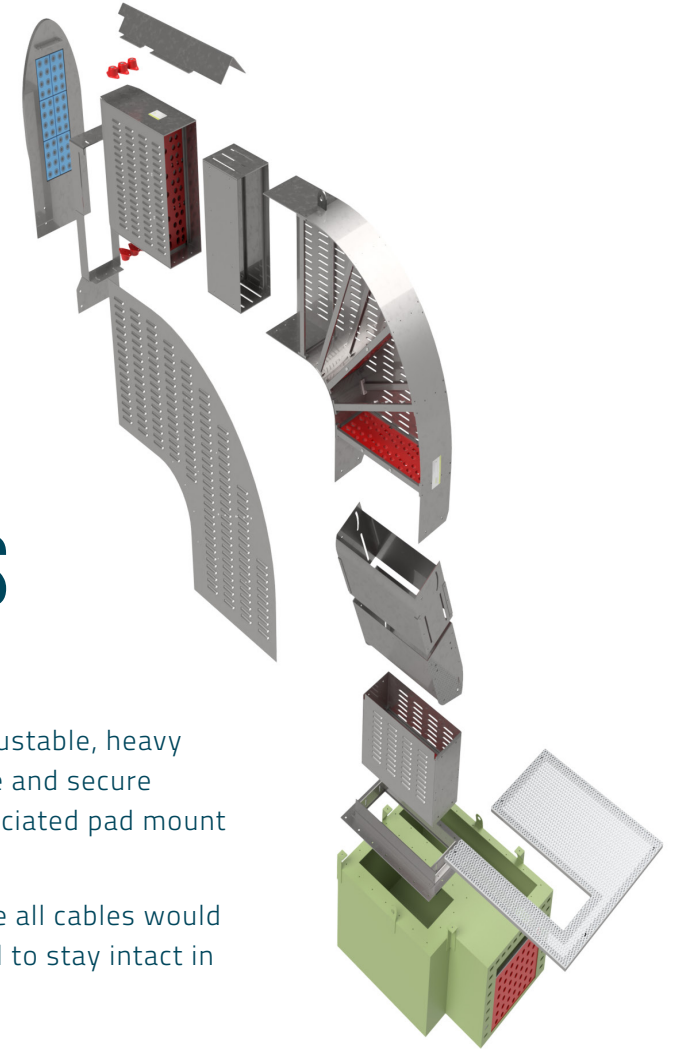

WIND TOWER CABLE TRAYS

56 custom heavy duty cable tray systems

Power Bus Way was commissioned to create an adjustable, heavy duty cable tray system that would provide a stable and secure connection between the wind towers and the associated pad mount transformers.

The cable tray was designed and rigorously tested to ensure all cables would remain protected from the elements. The tray was designed to stay intact in the event of falling ice from towers at heights of 500 ft.

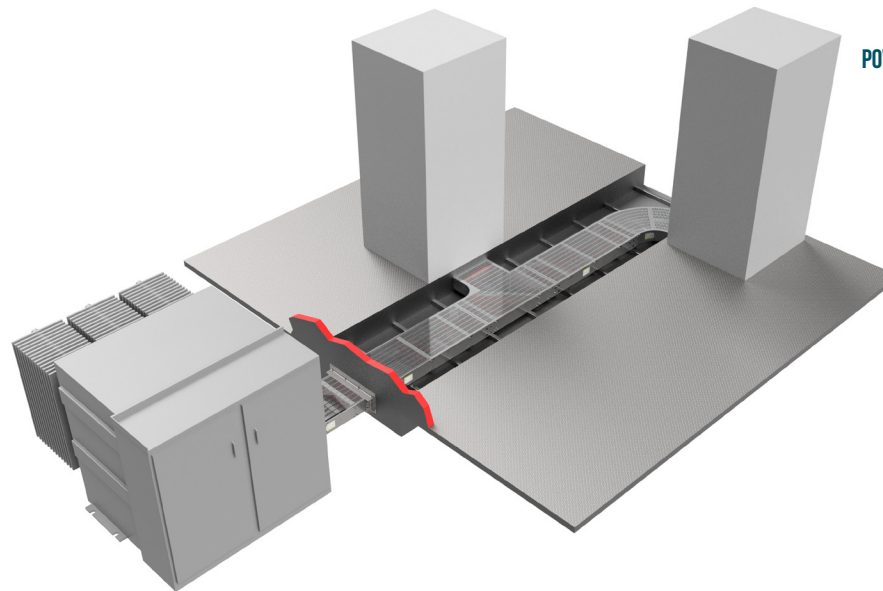

SOLAR INVERTER STATIONS

360V, 1369A

For this project, Power Bus Way built a total of 275 cable bus kits to connect between the system's inverters and dual secondary transformers. This included design and supply of a pre-assembled cable bus, complete with pre-terminated cables. This simplified the installation, reducing time and costs.

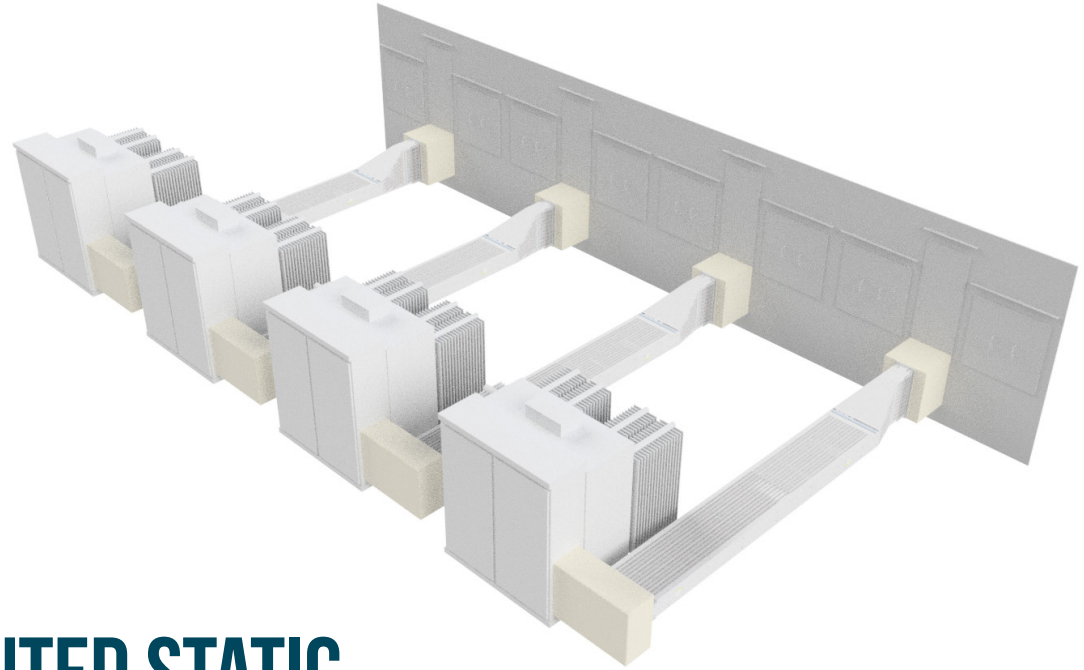

DISTRIBUTED STATIC COMPENSATOR

480V, 3737A

Power Bus Way supplied 32 cable bus systems to fit within a very limited space between S&C Electric's DSTATCOM and pad mount transformers.



TECHNICAL SPECIFICATIONS OF POWER BUS WAY CABLE BUS

Voltage range	up to 69kV
Current range	up to 8,000A
Cable Types (in both Aluminum and Copper)	USA: XHHW-2, RHH/RHW-2, MV-105 CANADA: RW-90, DLO, MV-105
Available cable sizes	250MCM up to 1000MCM
Cable configurations	3 phase, 3 wire 3 phase, 4 wire DC
Enclosure Size	6"H x 6"W to 12"H x 36"W
Certifications	USA: NEMA VE-1, NFPA 70 Article 370 compliant CANADA: CSA C/US 126-09, CSA 22.2 No. 273-14: certified, CE Code Compliant
Short circuit rating	up to 200kA
Min/Max ambient temp	-40C to 60C
Underground options	Precast or cast in place, pedestrian or heavy traffic grade
Cable securing method	Block style, max every 30in
Enclosure materials	Aluminum Stainless steel Painted options available

The applications of Power Bus Way cable bus and associated products are endless.

Discover the possibilities and solutions for your business today.

To request more information or a quote, please contact us at:

1.877.877.2091

sales-info@powerbusway.com

CUSTOM ELECTRICAL ENCLOSURES





Power Bus Way has extensive experience in designing and fabricating electrical enclosures for both low and medium voltage applications that meet or exceed industry standards. Suitable for all environments, the NEMA certified enclosures are available in aluminum, steel, and stainless steel.

ACCESSORIES





Power Bus Way is able to custom build accessories such as bus work and adapter plates. We can interface our cable bus with any equipment: transformers, switchgear, bus duct and more.

To provide the complete package, we also design and supply structural supports, customized to all site requirements.

POWER BUS WAY^{LT}

A safe, reliable, and cost effective alternative to bus duct,
cable tray and duct bank.

.....

6900 Davand Drive
Mississauga, ON L5T 1J5 Canada
sales-info@powerbusway.com

Telephone: 905-792-9333
Toll Free: 1-877-877-2091
Fax: 905-789-0510

